

Circulating Fluid Temperature Controller



Thermo-chiller **Standard Type**



Lightweight/Compact

Temperature stability $\pm 0.1^{\circ}\text{C}$



Same width for all models: **377 mm**

Model	Size [mm]	Weight	Cooling capacity (50 Hz)	Set temperature range
HRS012	W 377 x H 615 x D 500	40 kg	1100 W	5 to 40 °C
HRS018			1700 W	
HRS024			2100 W	
HRS030	W 377 x H 660 x D 500	47 kg	2600 W	
New HRS040	W 377 x H 676 x D 592	53 kg	3800 W	
HRS050	W 377 x H 976 x D 592	69 kg	4700 W	
HRS060		73 kg	4900 W	

Compatible with power supplies in Europe, Asia, Oceania, North, Central, and South America

- Single-phase 100 VAC (50/60 Hz), 115 VAC (60 Hz)
- Single-phase 200 to 230 VAC (50/60 Hz)

With heating function

Due to the heating method which uses discharged heat, a heater is unnecessary.

Convenient functions

p. 3

Timer operation function/Unit conversion function/Power failure auto-restart function/Anti-freezing operation function

Self-diagnosis function and check display

p. 4

35 types of alarm codes

Easy maintenance

p. 3

Toolless maintenance of filter

Communication function

p. 4

Equipped with serial communication (RS232C/RS485) and contact I/Os (2 inputs and 3 outputs) as standard

Environmentally friendly **R407C** **R410A** as refrigerant

HRS Series



CAT.EUS40-55G-UK

Temperature stability $\pm 0.1\text{ }^{\circ}\text{C}$ / Compact

A precision temperature control method which utilizes expansion valves and temperature sensors allowed for the realization of a product with a high temperature stability of $\pm 0.1\text{ }^{\circ}\text{C}$ and a small-size tank.

■ Air-cooled HRS□-A-□

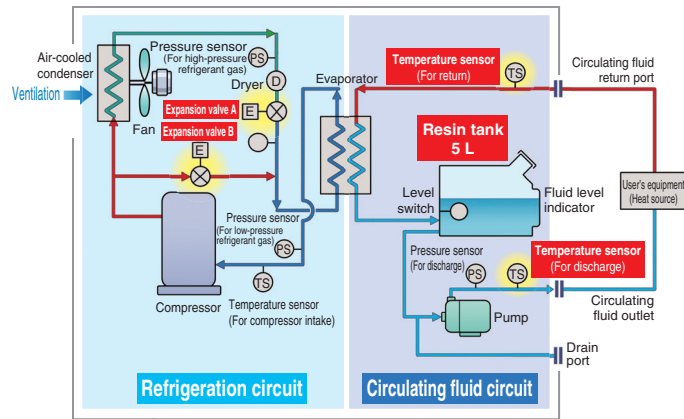

■ Water-cooled HRS□-W-□

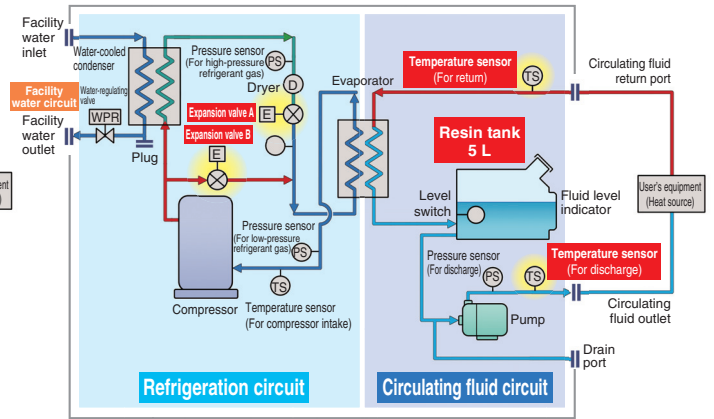

Refrigeration circuit

- The compressor compresses the refrigerant gas and discharges high-temperature, high-pressure refrigerant gas.
- In the case of air-cooled refrigeration, the high-temperature, high-pressure refrigerant gas is cooled down by fan ventilation in the air-cooled condenser, where it is then liquefied. In the case of water-cooled refrigeration, the refrigerant gas is cooled by the facility water in the facility water circuit in the water-cooled condenser, where it is then liquefied.
- The liquefied high-pressure refrigerant gas expands and its temperature lowers when it passes through expansion valve A, where it vaporises after receiving heat from the circulating fluid in the evaporator.
- The vaporised refrigerant gas is sucked into the compressor and compressed again.
- When heating the circulating fluid, the high-pressure, high-temperature refrigerant gas is bypassed into the evaporator by expansion valve B to heat the circulating fluid.

Point The combination of the precise control of **expansion valve A** for cooling and **expansion valve B** for heating allows for high temperature stability.

Circulating fluid circuit

- After the circulating fluid discharged from the pump is heated or cooled by the user's equipment, it returns to the thermo-chiller.
- The circulating fluid is controlled to remain at a set temperature by the refrigeration circuit. It will then be discharged to the user's equipment side again by the thermo-chiller.

Point Since the refrigeration circuit is controlled by the signals from **2 temperature sensors (for return and discharge)**, precise temperature control of the circulating fluid can be achieved. Therefore, there is no need for a tank with a large capacity to absorb the circulating fluid temperature difference, as high temperature stability can be achieved even with a **small-size tank**. This also contributes to space saving.

Facility water circuit

For water-cooled refrigeration HRS□-W-□

- The water-regulating valve opens and closes to keep the refrigerant gas pressure consistent. The facility water flow rate is controlled by the water-regulating valve.

Can be installed with both sides close to a wall

(HRS012/018/024 * Except option G)

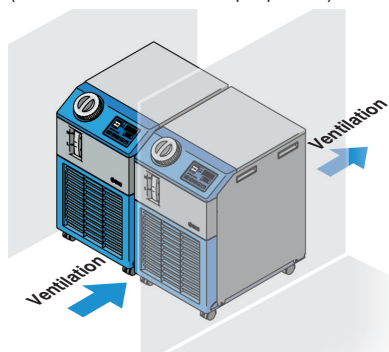

Reduced-height double condenser structure (HRS030/040/060)

Existing
 Multiple air-cooled condensers are provided on the top and bottom.

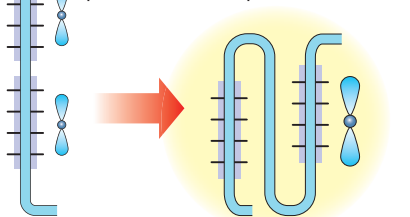

HRS030/040
 A maximum reduction in the height of the product has been achieved while expanding the cooling capacity by providing overlapped air-cooled condensers.

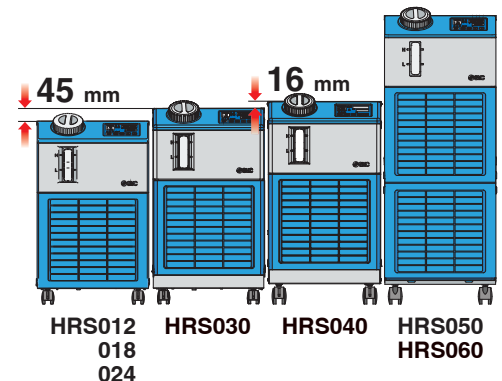

With heating function

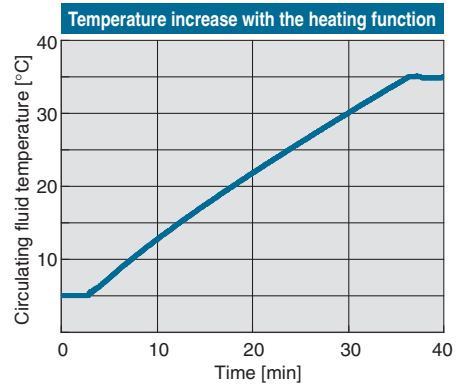
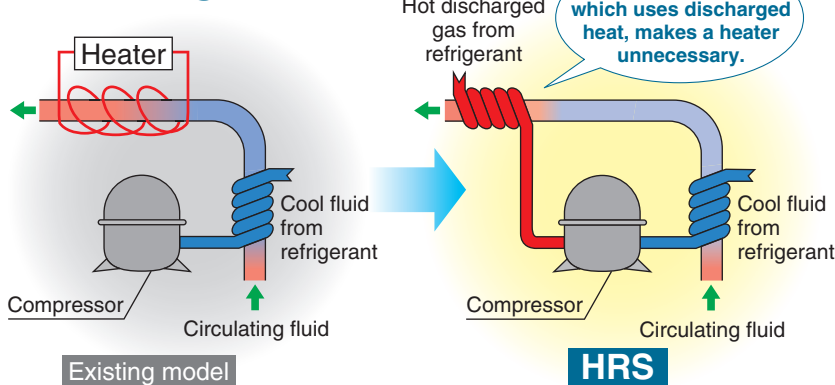

A heater is not required even when the ambient temperature is low.

* This is just an example diagram.

Simple operation

- Step 1 Press the **RUN/STOP** key.
- Step 2 Adjust the temperature setting with the **▼ / ▲** keys.
- Step 3 Press the **RUN/STOP** key to stop operation. Easy operation



Large digital display

The large digital display (7-segment and 4 digits) and 2-row display provide a clearer view of the current value (PV) and set value (SV).





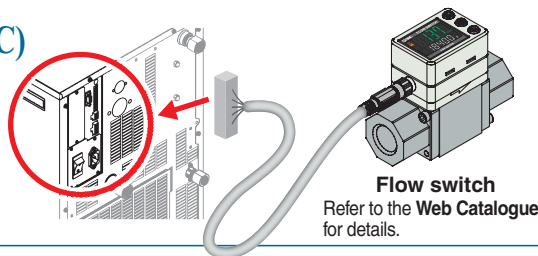

Power supply (24 VDC) available

Power can be supplied from the connector on the rear side of the HRS to external switches, etc.



Flow switch
Refer to the Web Catalogue for details.

Variations

Model	Cooling method	Cooling capacity [W] (50/60 Hz)	Single-phase 100 VAC (50/60 Hz) 115 VAC (50/60 Hz)	Single-phase 200 to 230 VAC (50/60 Hz)	Option p. 28	Optional accessories p. 31	International standards
 HRS012	Air-cooled refrigeration	1100/1300	●	●	<ul style="list-style-type: none"> With earth leakage breaker With automatic fluid fill function Applicable to deionised water piping 	<ul style="list-style-type: none"> Anti-quake bracket Piping conversion fitting (For air-cooled, water-cooled, and options) Concentration meter Bypass piping set Power supply cable DI filter set 	   *1 (UL Standards) Refer to pages 11 to 14 for details on applicable models.
 HRS018		1500/1700	●	—			
 HRS024		1700/1900	—	●			
 HRS030	Water-cooled refrigeration	2100/2400	—	●	<ul style="list-style-type: none"> High-pressure pump mounted (* The HRS050/060 cannot be selected.) SI unit only High-temperature environment specification (* The HRS030/040/050/060 cannot be selected.) 	<ul style="list-style-type: none"> Electric resistance sensor set/ Electric resistance control set Electric conductivity sensor set/ Electric conductivity control set Particle filter set Drain pan set (With water leakage sensor) Connector cover Analogue gateway unit Replacement type dustproof filter set Separately-installed power transformer Filter for circulating fluid fill port 	
HRS040		2600/3200	—	●			
HRS050		3800/4200	—	●			
HRS060		4700/5100	—	●			
HRS060		4900/5900	—	●			

*1 UL Standards: Applicable to only 60 Hz, To be obtained for the HRS040

Reduced maintenance hours for the pump

Now with a magnet pump*1

Due to the adoption of a sealless pump, no external leakage of the circulating fluid occurs. Also, periodic checking for pump leakage and replacement of the mechanical seal are not necessary.

*1 For products with the high-pressure pump option and for the HRS050/060, a mechanical seal pump is used.

Easy to check the circulating fluid level

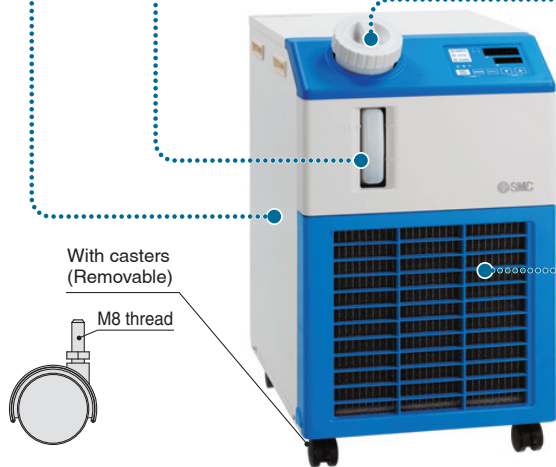
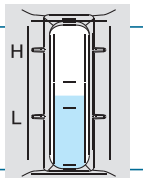

With casters (Removable)

M8 thread

Shaped for easy supply of circulating fluid

The angled supply port facilitates the easy supply of circulating fluid.

Filter for circulating fluid fill port (Optional accessory on page 44)

* After supplying the circulating fluid, the tank lid can be closed with the filter mounted.

Supply is possible even when 2 products are stacked.

Toolless inspection and cleaning of air-cooled condenser

Dustproof filter

Integrated with the grill of the front panel

Mounting and removal can be performed with ease.

Easy to remove dust, cutting chips, etc., stuck to the dustproof net with a brush or air blow

Easy to mount/ remove due to magnetic construction

Replacement type dustproof filter set (p. 42)

Suitable for use in excessively dusty atmospheres
 The disposable type filter reduces the time and effort required for cleaning.

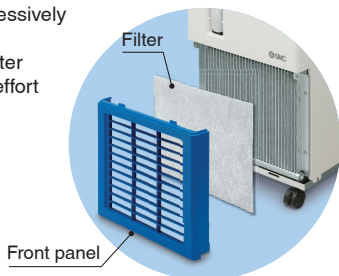

Particle filter set (p. 40)

Removes foreign matter in the circulating fluid
 Effective in preventing foreign matter from entering the user's equipment and chiller

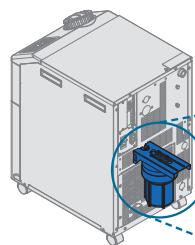

- Prevents pump malfunction
- Prevents the water-cooled condenser performance from falling

Convenient functions (Refer to the Operation Manual for details.)

Timer operation function

Timer for ON and OFF can be set in units of 0.5 h up to 99.5 h.

Ex.) Can be set to stop on Saturday and Sunday and restart on Monday morning

Ex. SE.02 "ON timer"

Timer The time remaining can be checked.



Unit conversion function

Temperature and pressure units can be changed.

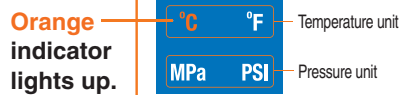

Orange indicator lights up.

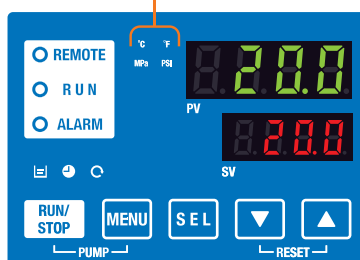

Power failure auto-restart function

Automatic restart after stoppage due to power failure, etc., is possible without pressing the RUN/STOP key, and remote operation is also possible.

Anti-freezing operation function

If the circulating fluid approaches its freezing point, for example, on a cold winter night, the pump operates automatically, and the heat generated by the pump warms the circulating fluid, preventing freezing.

Key-lock function

Can be set in advance to protect the set values from being changed by pressing keys by mistake.

Function to output a signal for completion of preparation

Notifies by communication when the temperature reaches the pre-set temperature range

Independent operation of the pump

The pump can be operated independently while the chiller is powered off. This allows you to check for leakages in piping and to remove the air.

Self-diagnosis function and check display

Display of 35 types of alarm codes For details, refer to page 26.

Operation is monitored at all times by the integrated sensor. Should any error occur, the self-diagnosis result is displayed by the applicable alarm code (35 types). This makes it easier to identify the cause of the alarm. Can be used before requesting service

Changeable alarm set values

Setting item	Set value
Circulating fluid discharge temperature rise	5 to 48 °C
Circulating fluid discharge temperature drop	1 to 39 °C
Circulating fluid discharge pressure rise	0.05 to 0.75 MPa*1
Circulating fluid discharge pressure drop	0.05 to 0.18 MPa*1

*1 Set values vary depending on the model.

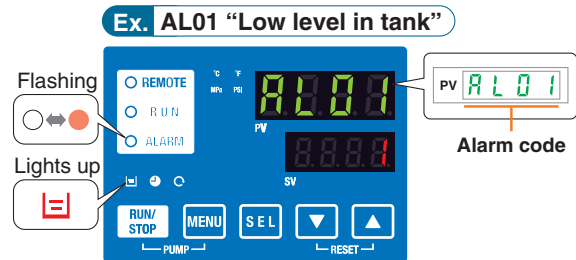

Alarm codes can be used for the notification of upcoming recommended maintenance.

The codes notify you when it's time to check the pump and fan motor. Helpful for facility maintenance

* A fan motor is not used in water-cooled refrigeration.

Check display

The internal temperature, pressure, and operating time of the product are displayed.

Ex. AL28 "Pump maintenance"

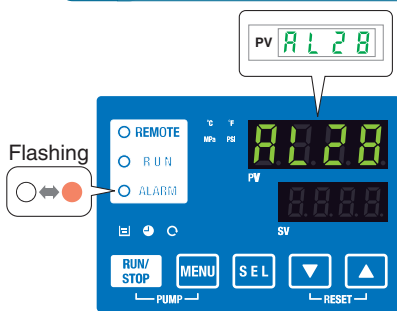

Ex. drv. "Accumulated operating time"

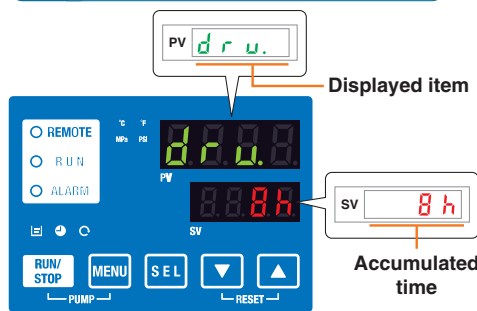

Displayed item
Circulating fluid outlet temperature
Circulating fluid return temperature
Compressor gas temperature
Circulating fluid outlet pressure
Compressor gas discharge pressure
Compressor gas return pressure
Accumulated operating time
Accumulated operating time of pump
Accumulated operating time of fan motor*1
Accumulated operating time of compressor

*1 These are displayed only for air-cooled refrigeration.

Communication function

Serial communication (RS232C/RS485) and contact I/Os (2 inputs and 3 outputs) are equipped as standard. This allows for communication with the user's equipment and system construction, depending on the application. A 24 VDC output can be also provided and is available for use with flow switches (SMC's PF2W, etc.).

Ex. 1 Remote signal I/O through serial communication

Remote operation is enabled (to start and stop operation) through serial communication.

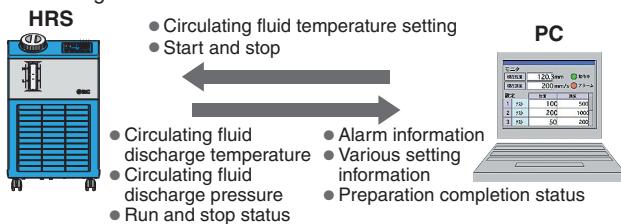

Ex. 3 Alarm and operation status (start, stop, etc.) signal output

The alarm and status generated in the product are assigned to 3 output signals based on their contents, which can then be output.

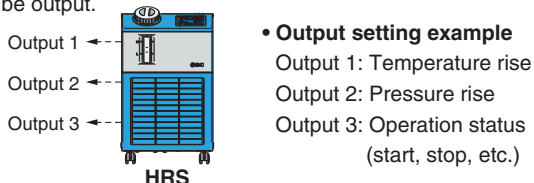



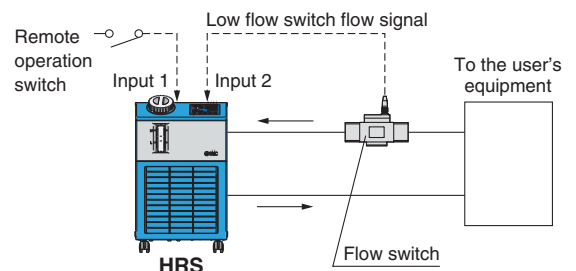

Ex. 2 Remote operation signal input

One of the contact inputs is used for remote operation and the other is used to monitor the flow of a flow switch. This is where their alarm outputs are taken in.



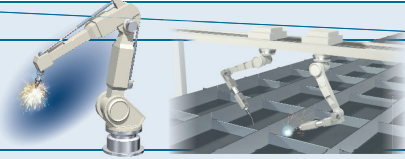
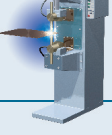
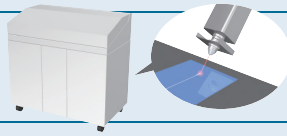
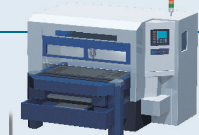

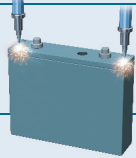
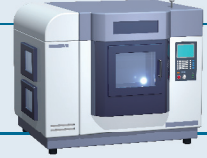
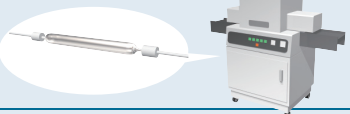
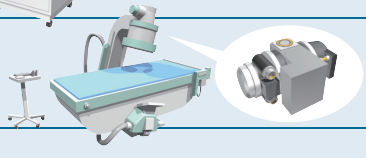
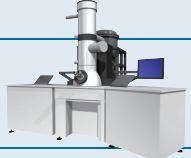
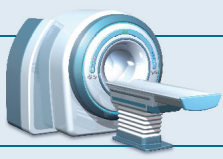
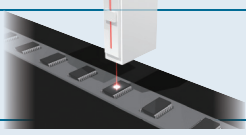

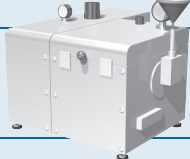
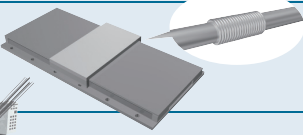
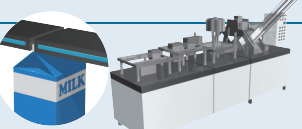

Power for flow switches (24 VDC) can be supplied by the thermo-chiller.

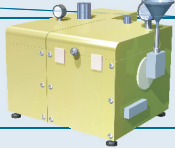
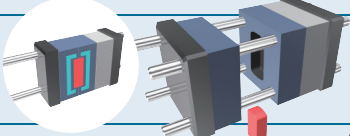
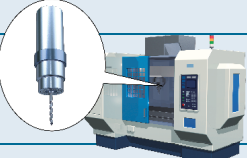
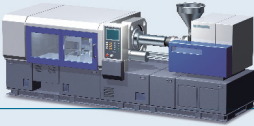
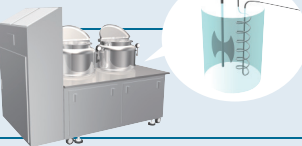
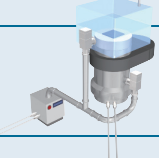
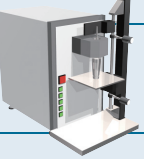
Application Examples

	Heat source	Automotive	Light electrical appliance	Food	Machinery	Medical	Semiconductor	Laser
Arc welding machines 	Torch	●			●			
Resistance welding machines 	Tip	●	●		●			
Laser welding machines 	Oscillator	●	●		●		●	
Laser beam machines 	Oscillator/ Power supply							●
Fiber lasers Oscillators Transmission cable connectors 								●
Secondary battery manufacturing processes 	Welded portion							●
3D metal printers Additive manufacturing 								●
UV curing devices 	Lamp	●	●	●		●		
X-ray instruments 			●			●	●	
Electronic microscopes 	Lens		●			●	●	
MRIs 						●		
Laser markers 	Oscillator	●	●	●		●	●	●
Ultrasonic wave inspection machines 	Oscillator	●	●		●			●
Atomizing devices Crushing equipment 	Blade			●				
Linear motors 	Motor	●			●			
Packaging lines (food) 	Dies/ Welded portions			●				

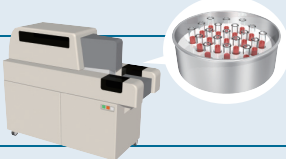
Application Examples

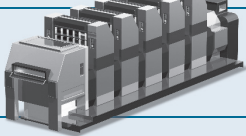
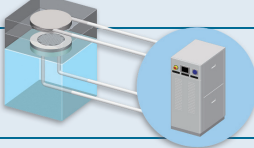
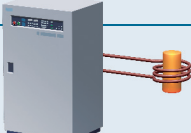
		Heat source	Automotive	Light electrical appliance	Food	Machinery	Medical	Semiconductor	Laser
Atomizing devices (food and cosmetics)		Sample/ Device			●	●			
Mold cooling		Mold	●	●	●		●		
Machining centers		Spindle				●			
Injection molding						●			
Temperature control of adhesive and paint materials		Paint material/ Welding materials	●	●	●				
Cooling of vacuum pumps		Pump	●					●	
Shrink fit machines		Workpiece	●			●			
Gas cylinder cabinets								●	
Testers				●				●	
Concentrating equipment		Test liquid			●		●		
Reagent cooling equipment		Reagent			●		●	●	
Cleaning machines		Cleaning solution		●				●	
Printing machines		Roller		●	●	●			
Chamber electrodes		Electrode						●	
High-frequency induction heating equipment		Power supply/ Heating coil	●			●			

Global Supply Network







SMC has a comprehensive network in the global market.

We now have a presence of more than 500 branch offices and distributors in 83 countries and regions worldwide, such as Asia, Oceania, North/Central/South America, and Europe. With this global network, we are able to provide a global supply of our substantial range of products and high-quality customer service. We also provide full support to local factories, foreign manufacturing companies, and Japanese companies in each country.



SMC Thermo-chiller Variations

Lots of variations are available according to the users' requirements.

Series	Temperature stability [°C]	Set temperature range [°C]	Cooling capacity [kW]													Environment	International standards		
			1.2	1.8	2.4	3	4	5	6	9	10	15	20	25	28				
 HRSE Basic type	±2.0	10 to 30	●	●	●													Indoor use	CE UK CA (Only 230 VAC type)
 HRS Standard type	±0.1	5 to 40	●	●	●	●	●	●	●									Indoor use	CE UK CA (Only 60 Hz)
 HRS090 Standard type	±0.5	5 to 35								●								Indoor use	CE UK CA (400 V as standard)
 HRS100/150 Standard type	±1.0	5 to 35									●	●						Outdoor installation IPX4	CE UK CA (400 V as standard)
 HRSH090 Inverter type	±0.1	5 to 40								●								Indoor use	CE UK CA (400 V as standard, 200 V as an option) (Only 200 V as an option)
 HRSH Inverter type	±0.1	5 to 35									●	●	●	●	●			Outdoor installation IPX4	CE UK CA (400 V as standard, 200 V as an option) (Only 200 V as an option)

Circulating Fluid/Facility Water Line Equipment

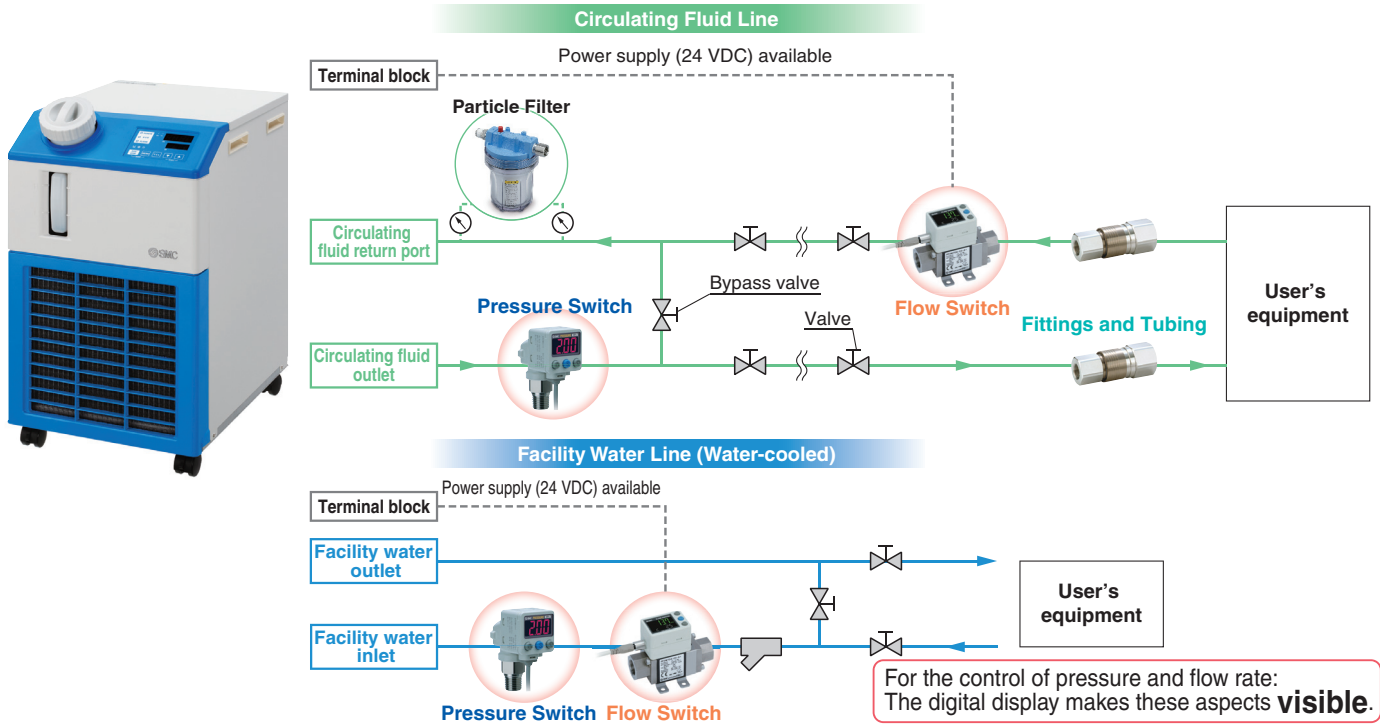

For the control of pressure and flow rate:
 The digital display makes these aspects **visible**.

Flow Switch: Monitors the flow rate and temperature of the circulating fluid and facility water

Refer to the Web Catalogue for details.

3-Colour Display Digital Flow Switch for Water **PF3W**
 Integrated with temperature sensor

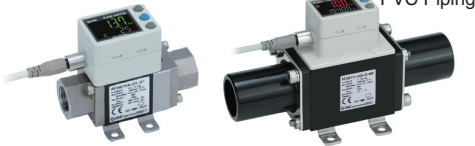

3-Colour Display Electromagnetic Type Digital Flow Switch **LFE**



Digital Flow Switch for Deionised Water and Chemical Liquids **PF2D**
 4-Channel Flow Monitor **PF2□200**



Pressure Switch: Monitors the pressure of the circulating fluid and facility water

Refer to the Web Catalog for details.



2-Colour Display High-Precision Digital Pressure Switch **ISE80**



Pressure Sensor for General Fluids **PSE56□, 57□**
 Pressure Sensor Controller **PSE200, 300, 300AC**

Particle Filter



p. 40

Fittings and Tubing

Refer to the Web Catalogue for details.

S Coupler **KK**



S Coupler/Stainless Steel (Stainless Steel 304) **KKA**



Metal One-touch Fittings **KQB2**

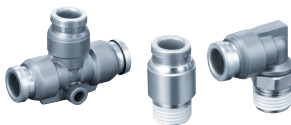

Stainless Steel 316 One-touch Fittings **KQG2**



Stainless Steel 316 Insert Fittings **KFG2**

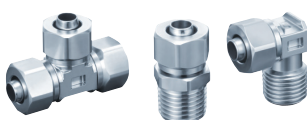

Fluoropolymer Fittings **LQ**



Tubing **T□**



Series	Material
T	Nylon
TU	Polyurethane
TH	FEP (Fluoropolymer)
TD	Modified PTFE (Soft fluoropolymer)
TL	Super PFA
TLM	PFA

CONTENTS

HRS Series **Standard Type**



Thermo-chiller HRS Series

How to Order/Specifications

Single-phase 100/115 VAC	p. 11
Single-phase 200 to 230 VAC	p. 13
Cooling Capacity	p. 15
Heating Capacity	p. 17
Pump Capacity/Required Facility Water Flow Rate	p. 20
Dimensions	p. 21
Recommended External Piping Flow	p. 25
Cable Specifications	p. 25
Operation Display Panel	p. 26
Alarm	p. 26
Communication Functions	p. 27

● Options

With Earth Leakage Breaker	p. 28
With Automatic Fluid Fill Function	p. 28
Applicable to Deionised Water Piping	p. 28
High-Pressure Pump Mounted	p. 28
SI Unit Only	p. 30
High-Temperature Environment Specification	p. 30

● Optional Accessories

① Anti-Quake Bracket	p. 33
② Piping Conversion Fitting (For Air-Cooled Refrigeration/Water-Cooled Refrigeration)	p. 33, 34
③ Piping Conversion Fitting (For Option)	p. 34
④ Concentration Meter	p. 35
⑤ Bypass Piping Set	p. 35
⑥ Power Supply Cable	p. 36
⑦ DI Filter Set	p. 37
⑧ Electric Resistance Sensor Set/Electric Resistance Control Set	p. 38
⑨ Electric Conductivity Sensor Set/Electric Conductivity Control Set	p. 39
⑩ Particle Filter Set	p. 40
⑪ Drain Pan Set (With Water Leakage Sensor)	p. 41
⑫ Connector Cover	p. 42
⑬ Analogue Gateway Unit	p. 42
⑭ Replacement Type Dustproof Filter Set	p. 42
⑮ Separately-Installed Power Transformer	p. 43
⑯ Filter for Circulating Fluid Fill Port	p. 44

● Cooling Capacity Calculation

Required Cooling Capacity Calculation	p. 45
Precautions on Cooling Capacity Calculation	p. 46
Circulating Fluid Typical Physical Property Values	p. 46

Specific Product Precautions	p. 47
------------------------------------	-------

Thermo-chiller Standard Type

Single-phase 100/115 VAC

HRS Series



How to Order

Air-cooled refrigeration

HRS 018 - A - 10 -

Cooling capacity

012	Cooling capacity 1100/1300 W (50/60 Hz)
018	Cooling capacity 1500/1700 W (50/60 Hz)

* UL Standards: Applicable to only 60 Hz

Cooling method

A	Air-cooled refrigeration
---	--------------------------

Pipe thread type

—	Rc
F	G (with PT-G conversion fitting set)
N	NPT (with PT-NPT conversion fitting set)

Power supply*1

Symbol	Power supply
10	Single-phase 100 VAC (50 Hz) 100 to 115 VAC (60 Hz)

*1 UL Standards: Applicable to only 60 Hz

Option

Symbol	Option
—	None
B	With earth leakage breaker
J	With automatic fluid fill function
M	Applicable to deionised water piping
T	High-pressure pump mounted*1
W	SI unit only

• When multiple options are combined, indicate symbols in alphabetical order.

*1 • The cooling capacity will decrease by about 300 W from the value in the catalogue.

• The pump has a mechanical seal in it and leakage could occur depending on circulating fluid quality. We recommend you to use the particle filter kit, HRS-PF003, as a preventive measure.

Specifications * There are different values from standard specifications. Refer to pages 28 to 30 for details.

Model		HRS012-A□-10	HRS018-A□-10	
Cooling method		Air-cooled refrigeration		
Refrigerant		R407C (HFC)		
Refrigerant charge		kg 0.32	0.33	
Control method		PID control		
Ambient temperature/Humidity/Altitude*1, 11		Temperature: 5 to 40 °C, Humidity: 30 to 70 %, Altitude: less than 3000 m		
Circulating fluid system	Circulating fluid*2	Tap water, 15 % ethylene glycol aqueous solution*4		
	Set temperature range*1	°C 5 to 40		
	Cooling capacity (50/60 Hz)*3	W 1100/1300	1500/1700	
	Heating capacity (50/60 Hz)*3	W 360/450		
	Temperature stability*5	°C ±0.1		
	Pump	Rated flow (50/60 Hz)*6, 7	l/min 7 (0.13 MPa)/7 (0.18 MPa)	
		Maximum flow rate (50/60 Hz)	l/min 27/29	
		Maximum pump head (50/60 Hz)	m 14/19	
		Output	W 200	
	Tank capacity	L	Approx. 5	
Port size		Rc1/2		
Fluid contact material		Stainless steel, Copper (Heat exchanger brazing), Bronze, Alumina ceramic, Carbon, PP, PE, POM, FKM, EPDM, PVC		
Electrical system	Power supply	Single-phase 100 VAC (50 Hz), 100 to 115 VAC (60 Hz) Allowable voltage range ±10 %*12		
	Circuit protector	A	15	
	Applicable earth leakage breaker capacity*8	A	15	
	Rated operating current	A	7.5/8.3	7.7/8.4
	Rated power consumption (50/60 Hz)*3	kVA	0.7/0.8	0.8/0.8
Noise level (50/60 Hz)*9	dB	58/55		
Accessories		Fitting (for drain outlet) 1 pc., Input/output signal connector 1 pc., Power supply connector 1 pc., Operation Manual (for installation/operation) 1, Quick Manual (with a clear case) 1, Alarm code list sticker 1, Ferrite core (for communication) 1 pc., Power supply cable: Option (sold separately) to be ordered or prepared by the user.		
Weight*10	kg	40		

*1 It should have no condensation.

*2 If tap water is used, use water that conforms to Water Quality Standards of the Japan Refrigeration and Air Conditioning Industry Association (JRA GL-02-1994 cooling water system - circulating type - make-up water). Refer to "Specific Product Precautions" for other usable circulating fluids.

*3 ① Ambient temperature: 25 °C, ② Circulating fluid temperature: 20 °C, ③ Circulating fluid rated flow, ④ Circulating fluid: Tap water

Refer to the cooling capacity and heating capacity graphs on pages 15 and 17 for details.

*4 Use a 15 % ethylene glycol aqueous solution if operating in a place where the circulating fluid temperature is 10 °C or less.

*5 Temperature at the thermo-chiller outlet when the circulating fluid flow is rated flow, and the circulating fluid outlet and return port are directly connected. Installation environment and the power supply are within specification range and stable.

*6 The capacity at the thermo-chiller outlet when the circulating fluid temperature is 20 °C.

*7 Required minimum flow rate for maintaining the cooling capacity or temperature stability. The specification of the cooling capacity and the temperature stability may not be satisfied if the flow rate is lower than the rated flow. (In such a case, use a bypass piping set (sold separately).)

*8 Purchase an earth leakage breaker with current sensitivity of 15 mA or 30 mA separately. (A product with an optional earth leakage breaker (option B) is also available. Refer to page 28.)

*9 Front: 1 m, height: 1 m, stable with no load, Other conditions → See *3.

*10 Weight in the dry state without circulating fluids

*11 If the product is used at altitude of 1000 m or higher, refer to "Operating Environment/Storage Environment" (page 48) Item 14 "• For altitude of 1000 m or higher."

*12 No continuous voltage fluctuation



How to Order

Water-cooled refrigeration **HRS 018 - W** - 10 -

Cooling capacity

012	Cooling capacity 1100/1300 W (50/60 Hz)
018	Cooling capacity 1500/1700 W (50/60 Hz)

* UL Standards: Applicable to only 60 Hz

Cooling method

W	Water-cooled refrigeration
----------	----------------------------

Pipe thread type

—	Rc
F	G (with PT-G conversion fitting set)
N	NPT (with PT-NPT conversion fitting set)

Power supply*1

Symbol	Power supply
10	Single-phase 100 VAC (50 Hz) 100 to 115 VAC (60 Hz)

*1 UL Standards: Applicable to only 60 Hz

Option

Symbol	Option
—	None
B	With earth leakage breaker
J	With automatic fluid fill function
M	Applicable to deionised water piping
T	High-pressure pump mounted*1
W	SI unit only

• When multiple options are combined, indicate symbols in alphabetical order.

*1 • The cooling capacity will decrease by about 300 W from the value in the catalogue.

• The pump has a mechanical seal in it and leakage could occur depending on circulating fluid quality. We recommend you to use the particle filter kit, HRS-PF003, as a preventive measure.

Specifications * There are different values from standard specifications. Refer to pages 28 to 30 for details.

Model		HRS012-W□-10	HRS018-W□-10	
Cooling method		Water-cooled refrigeration		
Refrigerant		R407C (HFC)		
Refrigerant charge	kg	0.25	0.26	
Control method		PID control		
Ambient temperature/Humidity/Altitude*1		Temperature: 5 to 40 °C, Humidity: 30 to 70 %, Altitude: less than 3000 m		
Circulating fluid system	Circulating fluid*2	Tap water, 15 % ethylene glycol aqueous solution*4		
	Set temperature range*1	5 to 40 °C		
	Cooling capacity (50/60 Hz)*3	1100/1300 W	1500/1700 W	
	Heating capacity (50/60 Hz)*3	360/450 W		
	Temperature stability*5	±0.1 °C		
	Pump	Rated flow (50/60 Hz)*6, 7	7 (0.13 MPa)/7 (0.18 MPa) l/min	
		Maximum flow rate (50/60 Hz)	27/29 l/min	
		Maximum pump head (50/60 Hz)	14/19 m	
		Output	200 W	
	Tank capacity	L	Approx. 5	
Port size		Rc1/2		
Fluid contact material		Stainless steel, Copper (Heat exchanger brazing), Bronze, Alumina ceramic, Carbon, PP, PE, POM, FKM, EPDM, PVC		
Facility water system	Temperature range	5 to 40 °C		
	Pressure range	0.3 to 0.5 MPa		
	Required flow rate (50/60 Hz)*11	8 l/min	12 l/min	
	Inlet-outlet pressure differential of facility water	0.3 or more MPa		
	Port size	Rc3/8		
Fluid contact material	Stainless steel, Copper (Heat exchanger brazing), Bronze, Synthetic rubber			
Electrical system	Power supply	Single-phase 100 VAC (50 Hz), 100 to 115 VAC (60 Hz) Allowable voltage range ±10 %*12		
	Circuit protector	15 A		
	Applicable earth leakage breaker capacity*8	15 A		
	Rated operating current	7.5/8.3 A	7.7/8.4 A	
	Rated power consumption (50/60 Hz)*3	0.7/0.8 kVA	0.8/0.8 kVA	
Noise level (50/60 Hz)*9	dB	58/55		
Accessories		Fitting (for drain outlet) 1 pc., Input/output signal connector 1 pc., Power supply connector 1 pc., Operation Manual (for installation/operation) 1, Quick Manual (with a clear case) 1, Alarm code list sticker 1, Ferrite core (for communication) 1 pc., Power supply cable: Option (sold separately) to be ordered or prepared by the user.		
Weight*10	kg	40		

*1 It should have no condensation.

*2 If tap water is used, use water that conforms to Water Quality Standards of the Japan Refrigeration and Air Conditioning Industry Association (JRA GL-02-1994 cooling water system - circulating type - make-up water). Refer to "Specific Product Precautions" for other usable circulating fluids.

*3 ① Ambient temperature: 25 °C, ② Circulating fluid temperature: 20 °C, ③ Circulating fluid rated flow, ④ Circulating fluid: Tap water, ⑤ Facility water temperature: 25 °C Refer to the cooling capacity and heating capacity graphs on pages 15 and 17 for details.

*4 Use a 15 % ethylene glycol aqueous solution if operating in a place where the circulating fluid temperature is 10 °C or less.

*5 Temperature at the thermo-chiller outlet when the circulating fluid flow is rated flow, and the circulating fluid outlet and return port are directly connected. Installation environment and the power supply are within specification range and stable.

*6 The capacity at the thermo-chiller outlet when the circulating fluid temperature is 20 °C.

*7 Required minimum flow rate for maintaining the cooling capacity or temperature stability. The specification of the cooling capacity and the temperature stability may not be satisfied if the flow rate is lower than the rated flow. (In such a case, use a bypass piping set (sold separately).)

*8 Purchase an earth leakage breaker with current sensitivity of 15 mA or 30 mA separately. (A product with an optional earth leakage breaker (option B) is also available. Refer to page 28.)

*9 Front: 1 m, height: 1 m, stable with no load, Other conditions → See *3.

*10 Weight in the dry state without circulating fluids

*11 Required flow rate when a load for the cooling capacity is applied at a circulating fluid temperature of 20 °C, and circulating fluid rated flow and facility water temperature of 25 °C.

*12 No continuous voltage fluctuation

Thermo-chiller Standard Type

Single-phase 200 to 230 VAC

HRS Series

RoHS



How to Order

Air-cooled refrigeration

HRS 018 - A - 20 -

Cooling capacity

012	Cooling capacity 1100/1300 W (50/60 Hz)
018	Cooling capacity 1700/1900 W (50/60 Hz)
024	Cooling capacity 2100/2400 W (50/60 Hz)
030	Cooling capacity 2600/3200 W (50/60 Hz)
040	Cooling capacity 3800/4200 W (50/60 Hz)
050	Cooling capacity 4700/5100 W (50/60 Hz)
060	Cooling capacity 4900/5900 W (50/60 Hz)

* UL Standards: Applicable to only 60 Hz
The pump of 050 and 060 have a mechanical seal and leakage could occur depending on circulating fluid quality. We recommend you to use the particle filter kit, HRS-PF004, as a preventive measure.

Cooling method

A	Air-cooled refrigeration
---	--------------------------

Pipe thread type

—	Rc
F	G (with PT-G conversion fitting set)
N	NPT (with PT-NPT conversion fitting set)

Option

Symbol	Option	Applicable model
—	None	
B	With earth leakage breaker	HRS012/018/024
J	With automatic fluid fill function	030/040/050/060
M	Applicable to deionised water piping	
T	High-pressure pump mounted*1	HRS012/018/024/030/040
G	High-temperature environment specification	HRS012/018/024
W	SI unit only	HRS012/018/024 030/040/050/060

* When multiple options are combined, indicate symbols in alphabetical order.
*1 The cooling capacity will decrease by about 300 W from the value in the catalogue.
The pump has a mechanical seal in it and leakage could occur depending on circulating fluid quality. We recommend you to use the particle filter kit, HRS-PF003, as a preventive measure.

Power supply*1

Symbol	Power supply
20	Single-phase 200 to 230 VAC (50/60 Hz)

*1 UL Standards: Applicable to only 60 Hz

Specifications

* There are different values from standard specifications. Refer to pages 28 to 30 for details.

Model	HRS012-A□-20	HRS018-A□-20	HRS024-A□-20	HRS030-A□-20	HRS040-A□-20	HRS050-A□-20	HRS060-A□-20
Cooling method	Air-cooled refrigeration						
Refrigerant	R407C (HFC)			R410A (HFC)			
Refrigerant charge kg	0.35	0.36	0.36	0.57	0.53	0.65	0.85
Control method	PID control						
Ambient temperature/Humidity/Altitude *1, 12	Temperature: 5 to 40 °C, High-temperature environment specification (option): 5 to 45 °C, Humidity: 30 to 70 %, Altitude: less than 3000 m						
Circulating fluid *2	Tap water, 15 % ethylene glycol aqueous solution*4						
Set temperature range *1 °C	5 to 40						
Cooling capacity (50/60 Hz) *3 W	1100/1300	1700/1900	2100/2400	2600/3200	3800/4200	4700/5100	4900/5900
Heating capacity (50/60 Hz) *3 W	530/650			600/640	900/1100	1100/1400	1000/1300
Temperature stability *5 °C	±0.1						
Rated flow (50/60 Hz) *6, 7 l/min	7 (0.13 MPa)/7 (0.18 MPa)					23 (0.24 MPa)/28 (0.32 MPa)	23 (0.21 MPa)/28 (0.29 MPa)
Maximum flow rate (50/60 Hz) l/min	27/29			34/40		31/42	29/38
Maximum pump head (50/60 Hz) m	14/19			50			
Output W	200			550			
Tank capacity L	Approx. 5						
Port size	Rc1/2						
Fluid contact material	Stainless steel, Copper (Heat exchanger brazing), Bronze, Alumina ceramic, Carbon, PP, PE, POM, FKM, EPDM, PVC						
Power supply	Single-phase 200 to 230 VAC (50/60 Hz) Allowable voltage range ±10 %						
Circuit protector A	10			20		30	
Applicable earth leakage breaker capacity *8 A	10			20		30	
Rated operating current A	4.6/5.1	4.7/5.2	5.1/5.9	5.2/6.0	7.9/9.6	8/11	8.9/11.5
Rated power consumption (50/60 Hz) *3 kVA	0.9/1.0	0.9/1.0	1.0/1.2	1.0/1.2	1.6/1.9	1.7/2.2	1.8/2.3
Noise level (50/60 Hz) *9 dB	60/61			62/65	64/66	65/68	66/68
Accessories	Fitting (for drain outlet) 1 pc.*11, Input/output signal connector 1 pc., Power supply connector 1 pc.*12, Operation Manual (for installation/operation) 1, Quick Manual (with a clear case) 1*12, Alarm code list sticker 1, Ferrite core (for communication) 1 pc., Power supply cable: Option (sold separately) to be ordered or prepared by the user.						
Weight *10 kg	43		47	53	69	73	

*1 It should have no condensation.

*2 If tap water is used, use water that conforms to Water Quality Standards of the Japan Refrigeration and Air Conditioning Industry Association (JRA GL-02-1994 cooling water system - circulating type - make-up water). Refer to "Specific Product Precautions" for other usable circulating fluids.

*3 ① Ambient temperature: 25 °C, ② Circulating fluid temperature: 20 °C, ③ Circulating fluid rated flow, ④ Circulating fluid: Tap water
Refer to the cooling capacity and heating capacity graphs on pages 15 to 19 for details.

*4 Use a 15 % ethylene glycol aqueous solution if operating in a place where the circulating fluid temperature is 10 °C or less.

*5 Temperature at the thermo-chiller outlet when the circulating fluid flow is rated flow, and the circulating fluid outlet and return port are directly connected. Installation environment and the power supply are within specification range and stable.

*6 The capacity at the thermo-chiller outlet when the circulating fluid temperature is 20 °C.

*7 Required minimum flow rate for maintaining the cooling capacity or temperature stability
The specification of the cooling capacity and the temperature stability may not be satisfied if the flow rate is lower than the rated flow. (In such a case, use a bypass piping set (sold separately).)

*8 Purchase an earth leakage breaker with current sensitivity of 30 mA separately.

(A product with an optional earth leakage breaker (option B) is also available.)

*9 Front: 1 m, height: 1 m, stable with no load, Other conditions → See *3.

*10 Weight in the dry state without circulating fluids

*11 It is not provided for the HRS050/060.

*12 It is not provided for the HRS040/050/060.

*13 If the product is used at altitude of 1000 m or higher, refer to "Operating Environment/Storage Environment" (page 48) Item 14 "• For altitude of 1000 m or higher."



How to Order

Water-cooled refrigeration HRS 018 - W - 20 -

Cooling capacity

012	Cooling capacity 1100/1300 W (50/60 Hz)
018	Cooling capacity 1700/1900 W (50/60 Hz)
024	Cooling capacity 2100/2400 W (50/60 Hz)
030	Cooling capacity 2600/3200 W (50/60 Hz)
040	Cooling capacity 3800/4200 W (50/60 Hz)
050	Cooling capacity 4700/5100 W (50/60 Hz)
060	Cooling capacity 4900/5900 W (50/60 Hz)

* UL Standards: Applicable to only 60 Hz

The pump of 050 and 060 have a mechanical seal and leakage could occur depending on circulating fluid quality. We recommend you to use the particle filter kit, HRS-PF004, as a preventive measure.

Cooling method

W	Water-cooled refrigeration
---	----------------------------

Pipe thread type

—	Rc
F	G (with PT-G conversion fitting set)
N	NPT (with PT-NPT conversion fitting set)

Option

Symbol	Option	Applicable model
—	None	
B	With earth leakage breaker	HRS012/018/024
J	With automatic fluid fill function	030/040/050/060
M	Applicable to deionised water piping	
T	High-pressure pump mounted*1	HRS012/018/024/030/040
W	SI unit only	HRS012/018/024 030/040/050/060

• When multiple options are combined, indicate symbols in alphabetical order.
*1 The cooling capacity will decrease by about 300 W from the value in the catalogue.

The pump has a mechanical seal in it and leakage could occur depending on circulating fluid quality. We recommend you to use the particle filter kit, HRS-PF003, as a preventive measure.

Power supply*1

Symbol	Power supply
20	Single-phase 200 to 230 VAC (50/60 Hz)

*1 UL Standards: Applicable to only 60 Hz

Specifications * There are different values from standard specifications. Refer to pages 28 to 30 for details.

Model	HRS012-W□-20	HRS018-W□-20	HRS024-W□-20	HRS030-W□-20	HRS040-W□-20	HRS050-W□-20	HRS060-W□-20		
Cooling method	Water-cooled refrigeration								
Refrigerant	R407C (HFC)			R410A (HFC)					
Refrigerant charge kg	0.3	0.31	0.31	0.5	0.6	0.65	0.75		
Control method	PID control								
Ambient temperature/Humidity/Altitude*1	Temperature: 5 to 40 °C, Humidity: 30 to 70 %, Altitude: less than 3000 m								
Circulating fluid system	Circulating fluid*2	Tap water, 15 % ethylene glycol aqueous solution*4							
	Set temperature range*1 °C	5 to 40							
	Cooling capacity (50/60 Hz)*3 W	1100/1300	1700/1900	2100/2400	2600/3200	3800/4200	4700/5100	4900/5900	
	Heating capacity (50/60 Hz)*3 W	530/650		400/600		700/1000		1000/1300	
	Temperature stability*5 °C	±0.1							
	Pump	Rated flow (50/60 Hz)*6, 7 l/min	7 (0.13 MPa)/7 (0.18 MPa)				23 (0.24 MPa)/28 (0.32 MPa)		23 (0.21 MPa)/28 (0.29 MPa)
		Maximum flow rate (50/60 Hz) l/min	27/29		34/40		31/42		29/38
		Maximum pump head (50/60 Hz) m	14/19			50		50	
		Output W	200			550			
	Tank capacity L	Approx. 5							
Port size	Rc1/2								
Fluid contact material	Stainless steel, Copper (Heat exchanger brazing), Bronze, Alumina ceramic, Carbon, PP, PE, POM, FKM, EPDM, PVC								
Facility water system	Temperature range °C	5 to 40							
	Pressure range MPa	0.3 to 0.5							
	Required flow rate (50/60 Hz)*11 l/min	8	12	14	15	15	16	17	
	Inlet-outlet pressure differential of facility water MPa	0.3 or more							
	Port size	Rc3/8				Rc1/2			
Fluid contact material	Stainless steel, Copper (Heat exchanger brazing), Bronze, Synthetic rubber								
Electrical system	Power supply	Single-phase 200 to 230 VAC (50/60 Hz) Allowable voltage range ±10 %							
	Circuit protector A	10			20				
	Applicable earth leakage breaker capacity*8 A	10							
	Rated operating current A	4.6/5.1	4.7/5.2	5.1/5.9	5.2/6.0	6.9/8.4	7.6/10	7.6/10.4	
	Rated power consumption (50/60 Hz)*3 KVA	0.9/1.0	0.9/1.0	1.0/1.2	1.0/1.2	1.5/1.7	1.5/2.0	1.5/2.1	
Noise level (50/60 Hz)*9 dB	60/61		62/65		64/66		65/68		
Accessories	Fitting (for drain outlet) 1 pc.*12, Input/output signal connector 1 pc., Power supply connector 1 pc.*13, Operation Manual (for installation/operation) 1, Quick Manual (with a clear case) 1*13, Alarm code list sticker 1, Ferrite core (for communication) 1 pc., Power supply cable: Option (sold separately) to be ordered or prepared by the user.								
Weight*10 kg	43	46	53	67					

*1 It should have no condensation.

*2 If tap water is used, use water that conforms to Water Quality Standards of the Japan Refrigeration and Air Conditioning Industry Association (JRA GL-02-1994 cooling water system - circulating type - make-up water). Refer to "Specific Product Precautions" for other usable circulating fluids.

*3 ① Ambient temperature: 25 °C, ② Circulating fluid temperature: 20 °C, ③ Circulating fluid rated flow, ④ Circulating fluid: Tap water, ⑤ Facility water temperature: 25 °C Refer to the cooling capacity and heating capacity graphs on pages 15 to 19 for details.

*4 Use a 15 % ethylene glycol aqueous solution if operating in a place where the circulating fluid temperature is 10 °C or less.

*5 Temperature at the thermo-chiller outlet when the circulating fluid flow is rated flow, and the circulating fluid outlet and return port are directly connected. Installation environment and the power supply are within specification range and stable.

*6 The capacity at the thermo-chiller outlet when the circulating fluid temperature is 20 °C.

*7 Required minimum flow rate for maintaining the cooling capacity or temperature stability The specification of the cooling capacity and the temperature stability may not be satisfied if the flow rate is lower than the rated flow. (In such a case, use a bypass piping set (sold separately).)

*8 Purchase an earth leakage breaker with current sensitivity of 30 mA separately. (A product with an optional earth leakage breaker (option B) is also available.)

*9 Front: 1 m, height: 1 m, stable with no load, Other conditions → See *3.

*10 Weight in the dry state without circulating fluids

*11 Required flow rate when a load for the cooling capacity is applied at a circulating fluid temperature of 20 °C, and circulating fluid rated flow and facility water temperature of 25 °C.

*12 It is not provided for the HRS050/060.

*13 It is not provided for the HRS040/050/060.

* If the product is used at altitude of 1000 m or higher, refer to "Operating Environment/Storage Environment" (page 48) Item 14 ** For altitude of 1000 m or higher.

Cooling Capacity

* For models with high-pressure pump mounted (-T), the cooling capacity will decrease by about 300 W from each graph.

HRS012-A-10, HRS012-W-10 (Single-phase 100/115 VAC) (50 Hz)

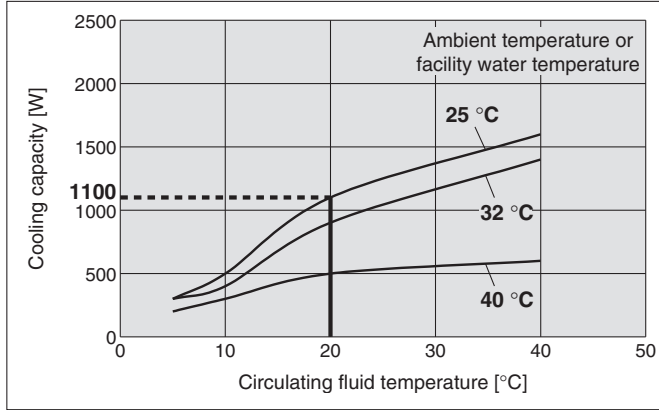

(60 Hz)

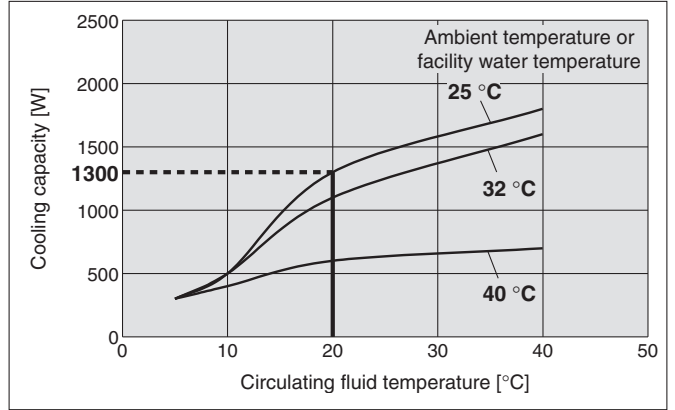

HRS018-A-10, HRS018-W-10 (Single-phase 100/115 VAC) (50 Hz)

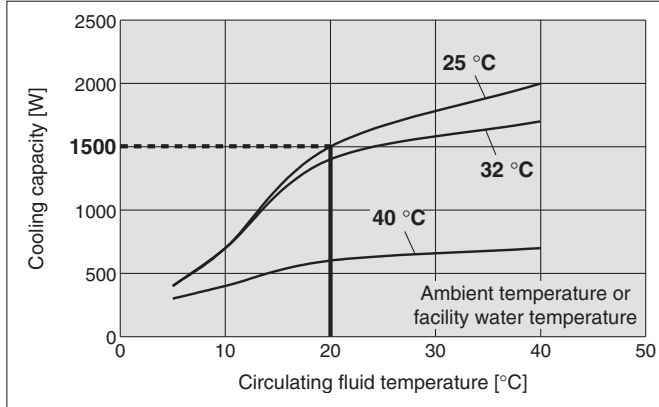

(60 Hz)

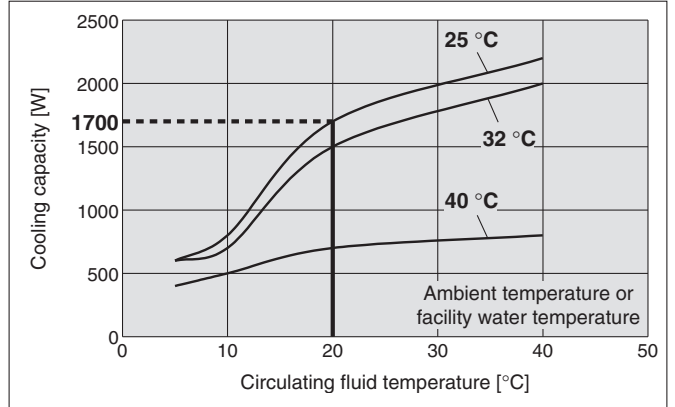

HRS012-A-20, HRS012-W-20 (Single-phase 200 to 230 VAC) (50 Hz)

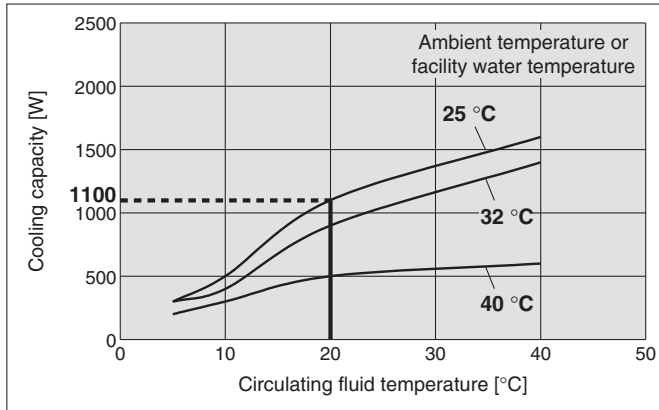

(60 Hz)

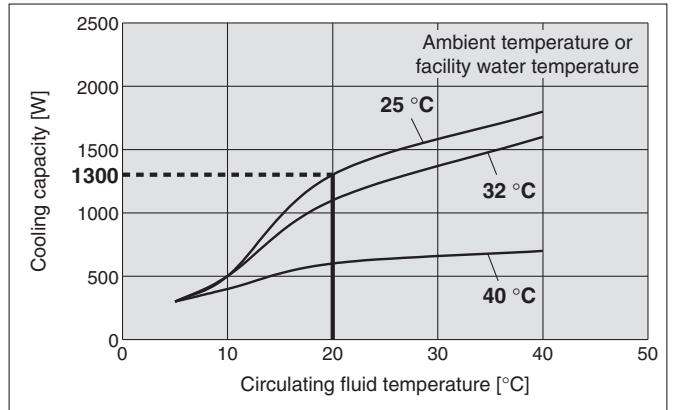

HRS018-A-20, HRS018-W-20 (Single-phase 200 to 230 VAC) (50 Hz)

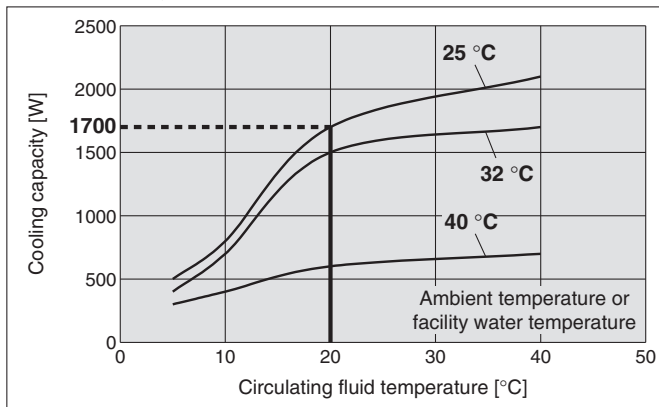

(60 Hz)

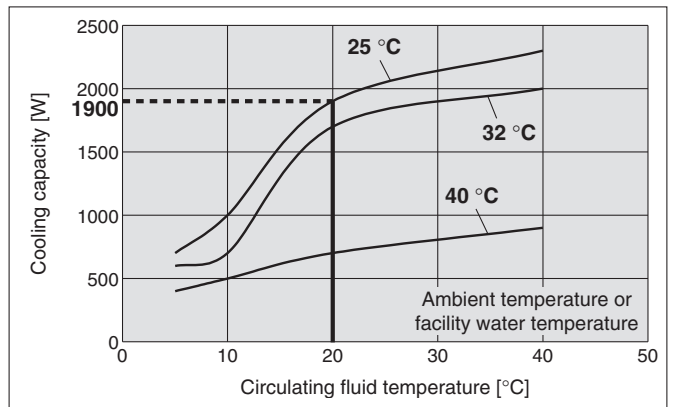

* If the product is used at altitude of 1000 m or higher, refer to "Operating Environment/Storage Environment" (page 48) Item 14 * For altitude of 1000 m or higher.

Cooling Capacity

* For models with high-pressure pump mounted (-T), the cooling capacity will decrease by about 300 W from each graph.

HRS024-A-20, HRS024-W-20 (Single-phase 200 to 230 VAC) (50 Hz)

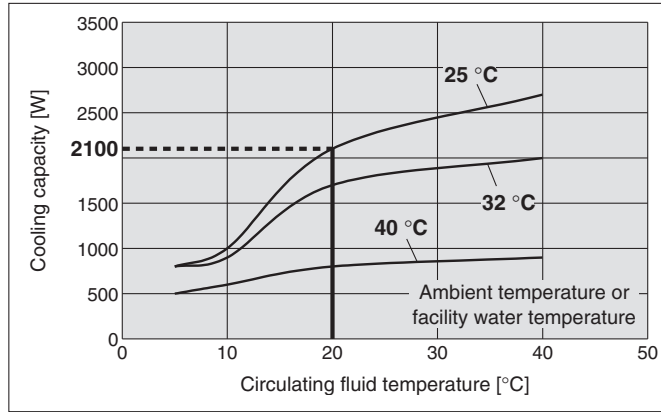

(60 Hz)

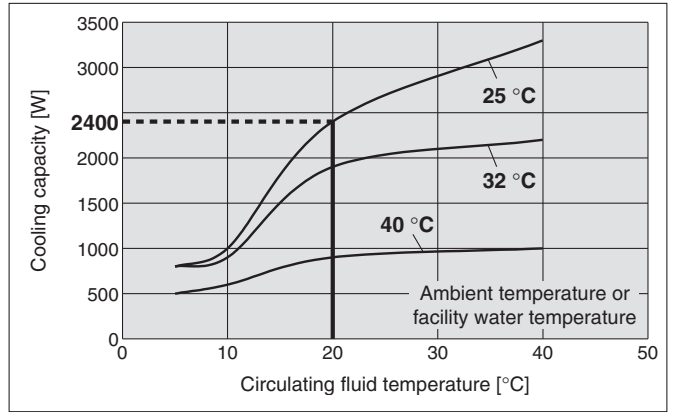

HRS030-A-20, HRS030-W-20 (Single-phase 200 to 230 VAC) (50 Hz)

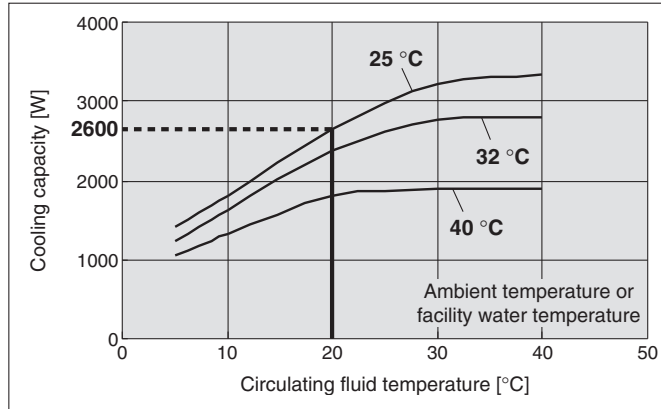

(60 Hz)

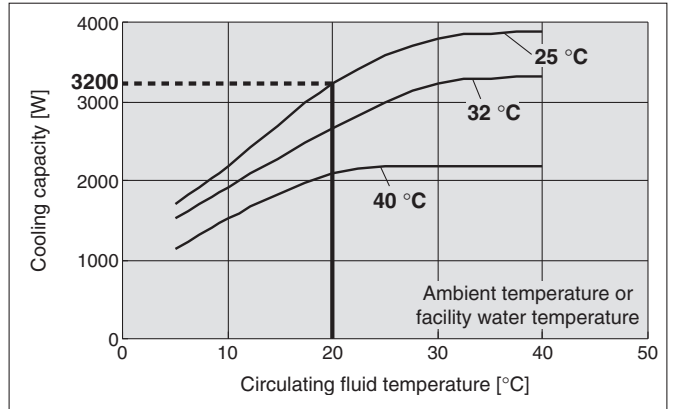

HRS040-A-20, HRS040-W-20 (Single-phase 200 to 230 VAC) (50 Hz)

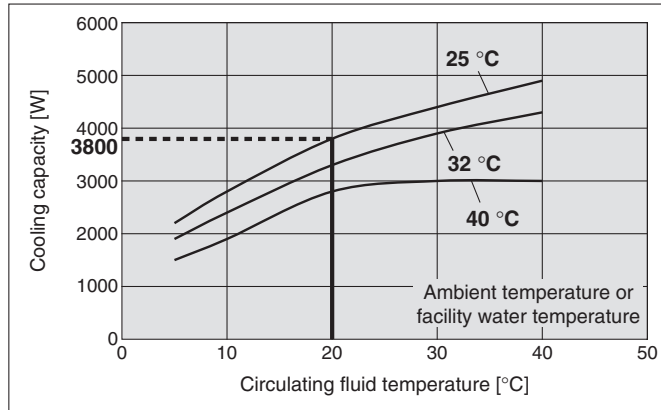

(60 Hz)

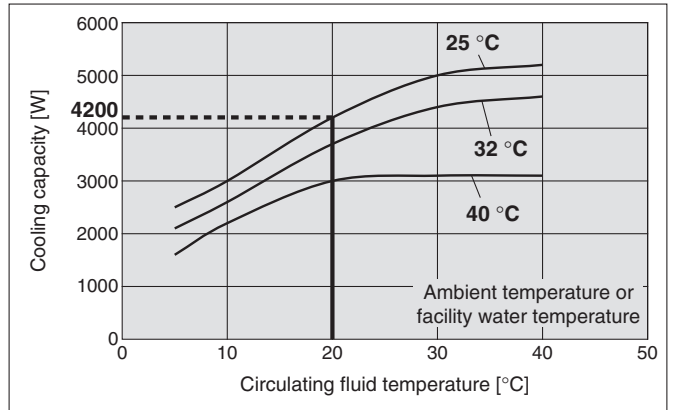

HRS050-A-20, HRS050-W-20 (Single-phase 200 to 230 VAC) (50 Hz)

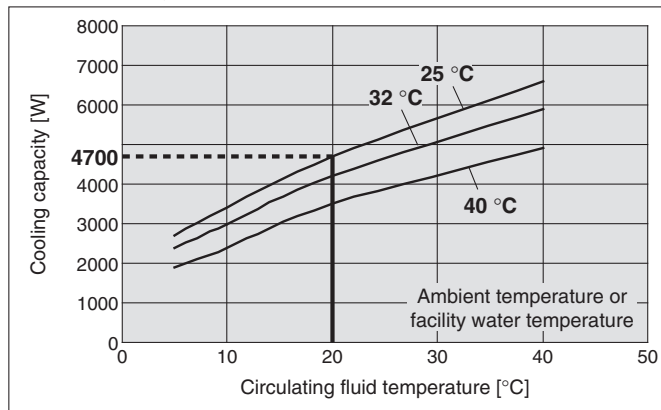

(60 Hz)

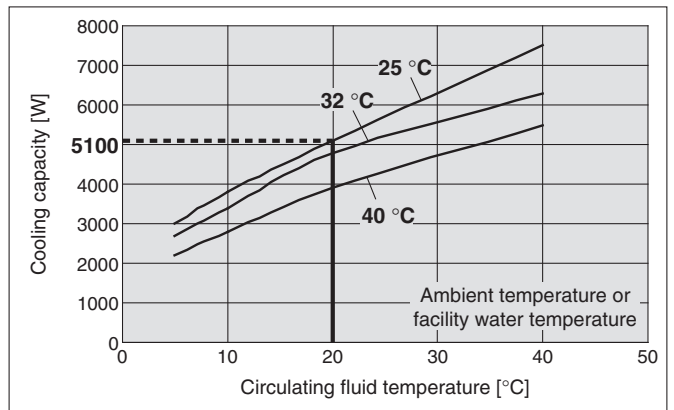

* If the product is used at altitude of 1000 m or higher, refer to "Operating Environment/Storage Environment" (page 48) Item 14 * For altitude of 1000 m or higher.

Cooling Capacity

* For models with high-pressure pump mounted (-T), the cooling capacity will decrease by about 300 W from each graph.

HRS060-A-20, HRS060-W-20 (Single-phase 200 to 230 VAC) (50 Hz)

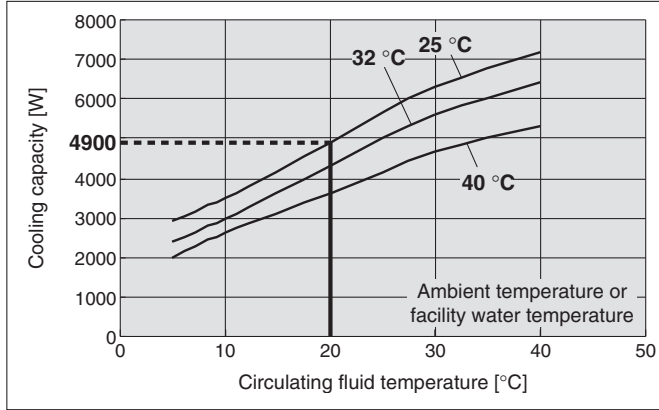

(60 Hz)

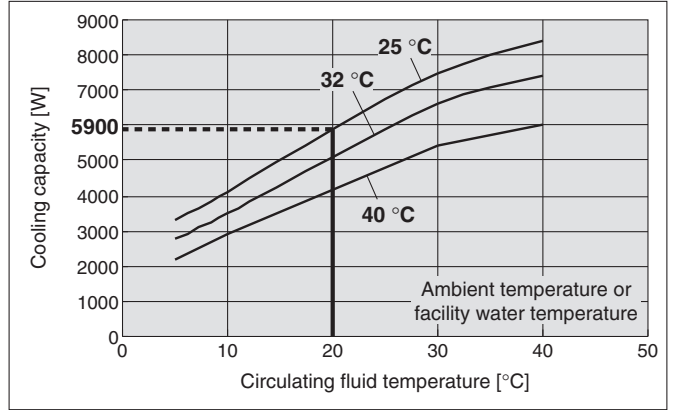

Heating Capacity

HRS⁰¹²₀₁₈-A-W-10 (Single-phase 100/115 VAC)

(50 Hz)

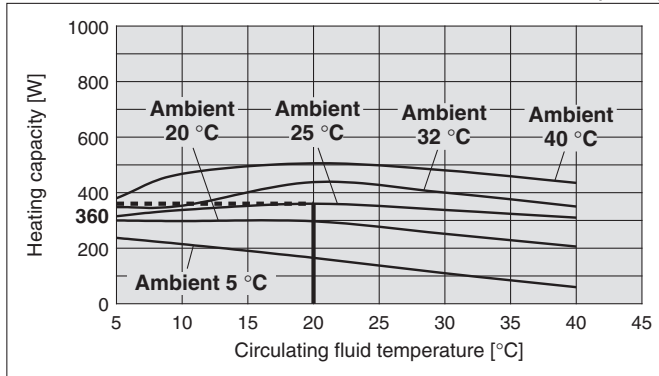

(60 Hz)

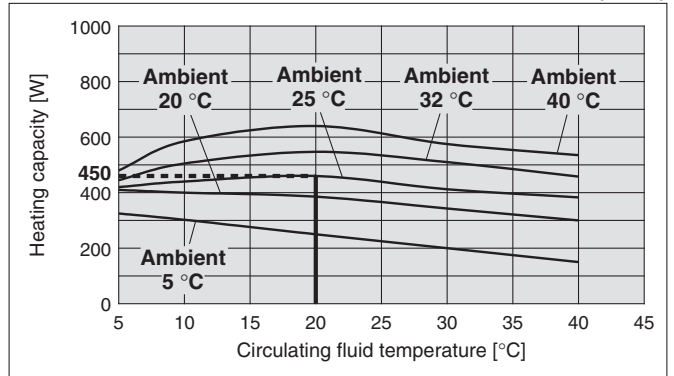

HRS⁰¹²₀₁₈-A-W-20 (Single-phase 200 to 230 VAC)

(50 Hz)

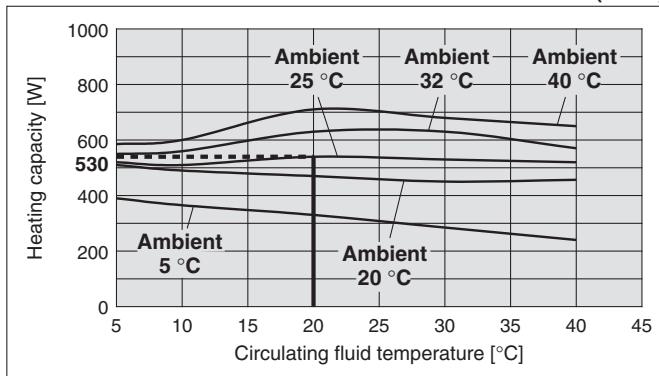

(60 Hz)

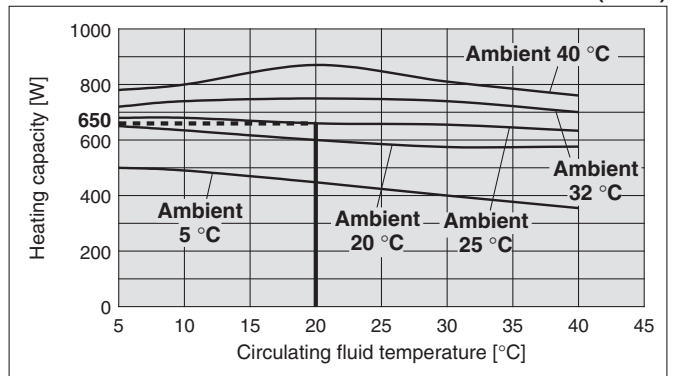

HRS030-A-20 (Single-phase 200 to 230 VAC)

(50 Hz)

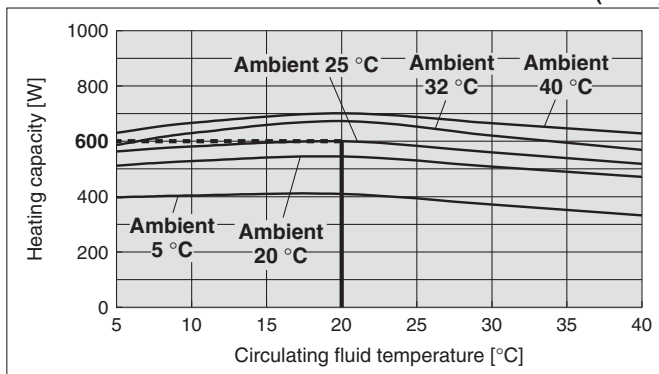

(60 Hz)

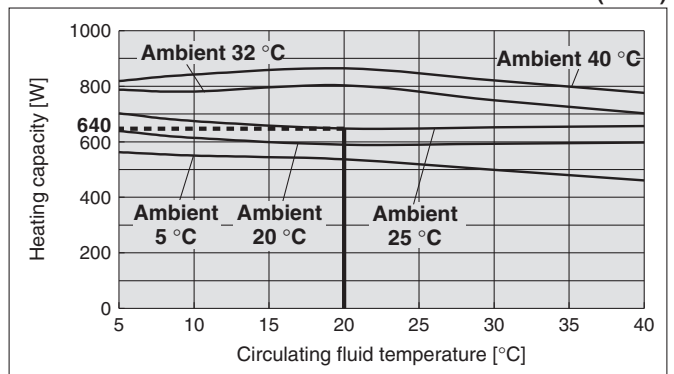

Heating Capacity

HRS030-W-20 (Single-phase 200 to 230 VAC) (50 Hz)

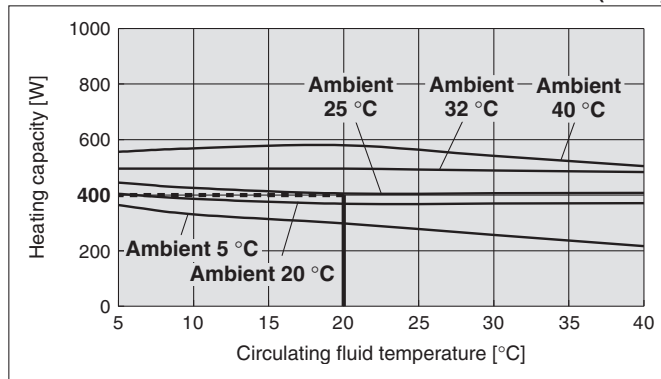

(60 Hz)

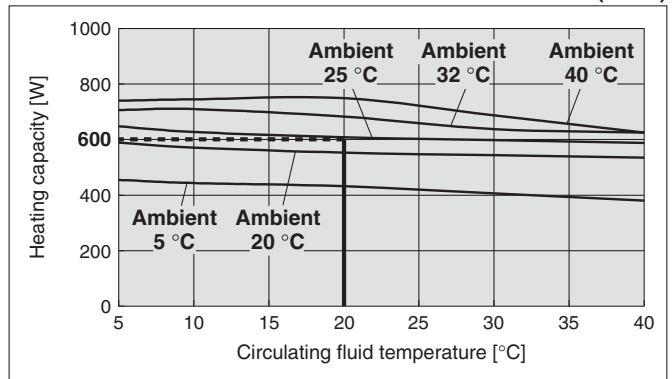

HRS040-A-20 (Single-phase 200 to 230 VAC) (50 Hz)

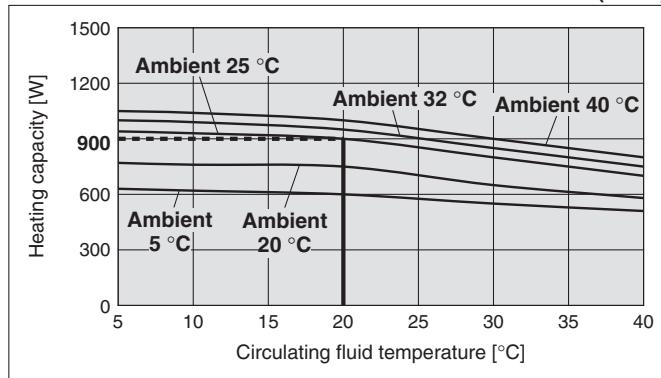

(60 Hz)

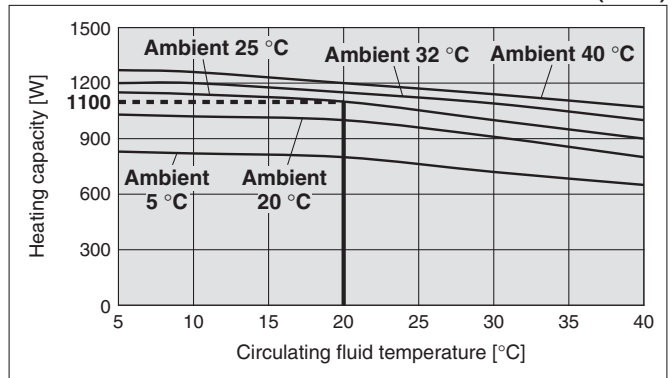

HRS040-W-20 (Single-phase 200 to 230 VAC) (50 Hz)

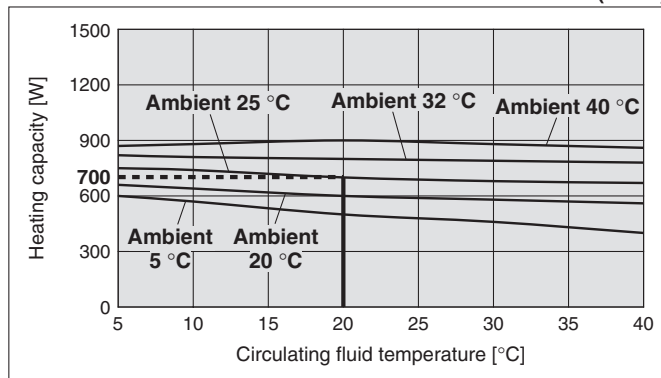

(60 Hz)

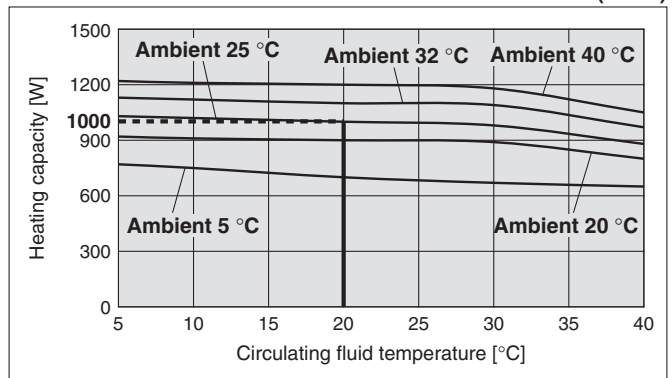

HRS050-A-20 (Single-phase 200 to 230 VAC) (50 Hz)

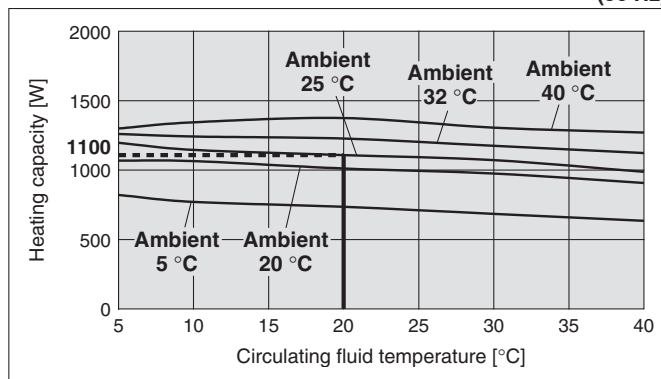

(60 Hz)

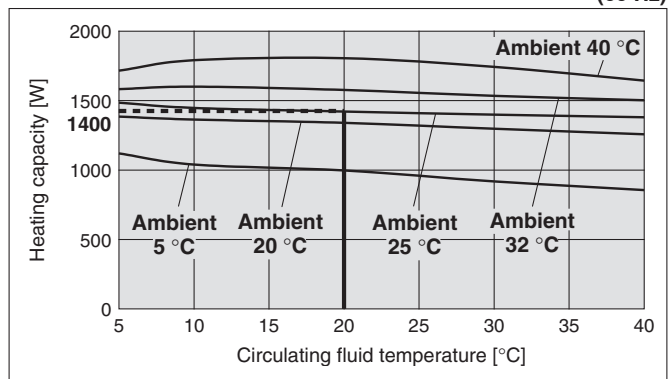

Heating Capacity

HRS050-W-20 (Single-phase 200 to 230 VAC) (50 Hz)

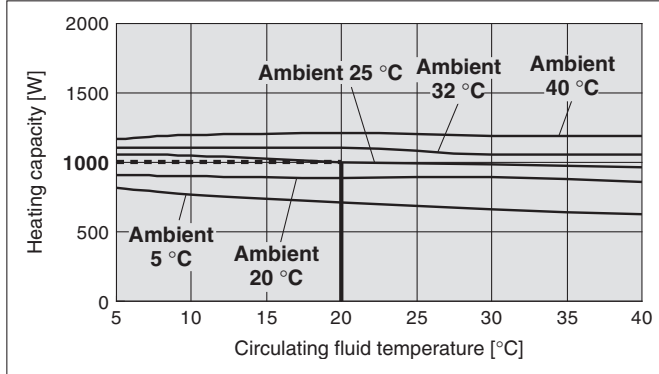

(60 Hz)

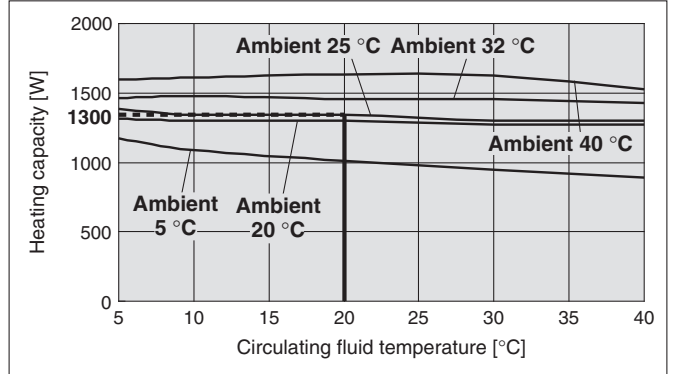

HRS060-A-20 (Single-phase 200 to 230 VAC) (50 Hz)

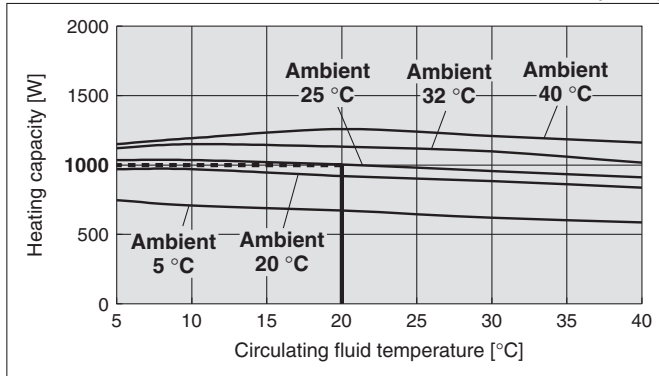

(60 Hz)

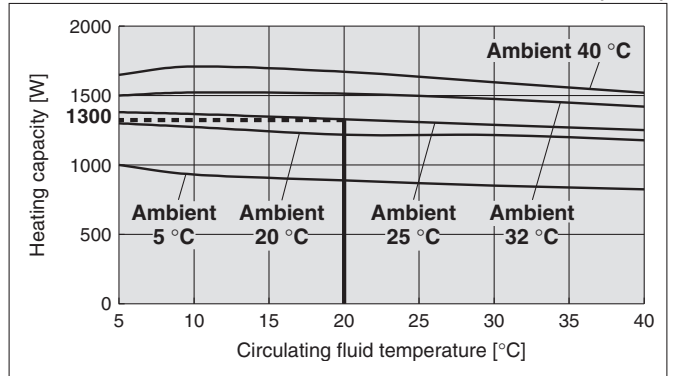

HRS060-W-20 (Single-phase 200 to 230 VAC) (50 Hz)

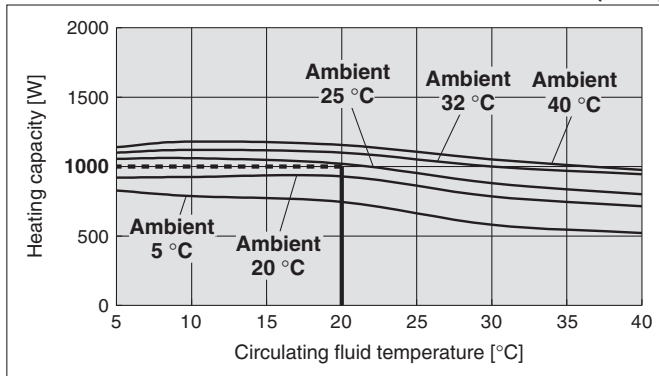

(60 Hz)

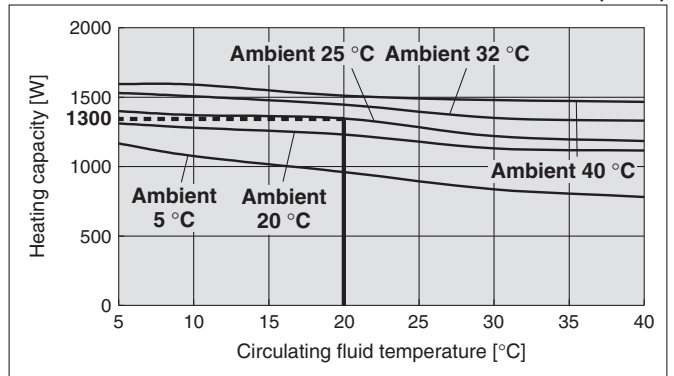

Pump Capacity

HRS₀₁₈⁰¹²-A_W-10 (Single-phase 100/115 VAC)

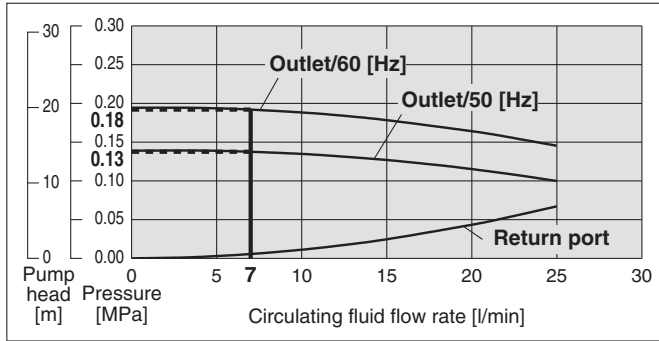

HRS₀₂₄⁰¹²-A_W-20 (Single-phase 200 to 230 VAC)

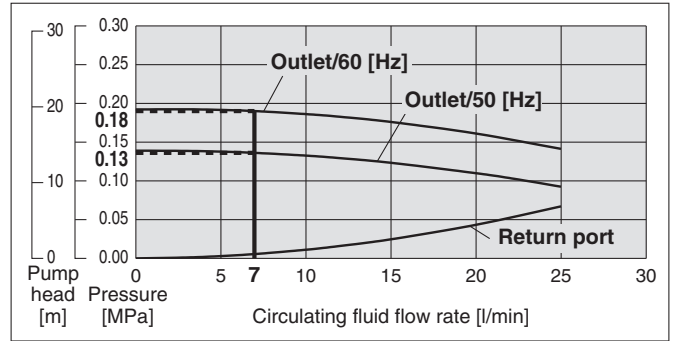

HRS₀₄₀⁰³⁰-A_W-20 (Single-phase 200 to 230 VAC)

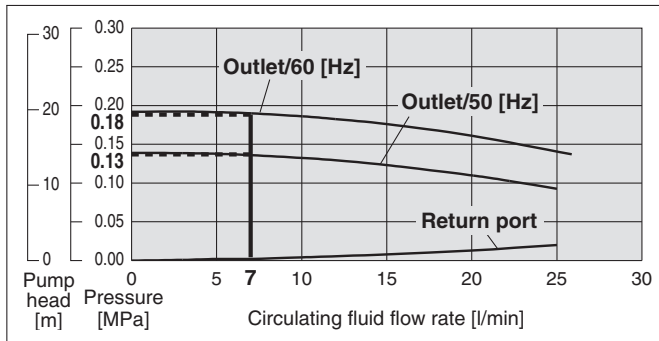

HRS050-A_W-20 (Single-phase 200 to 230 VAC)

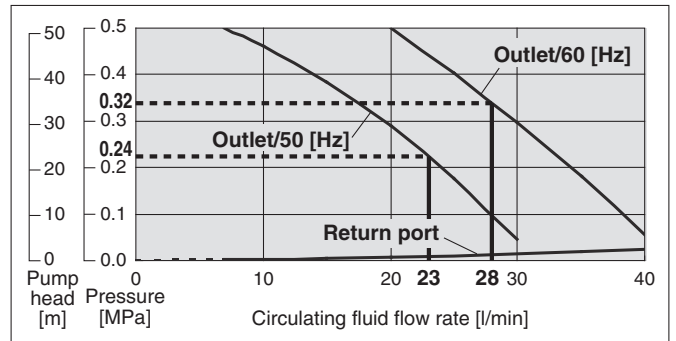

HRS060-A_W-20 (Single-phase 200 to 230 VAC)

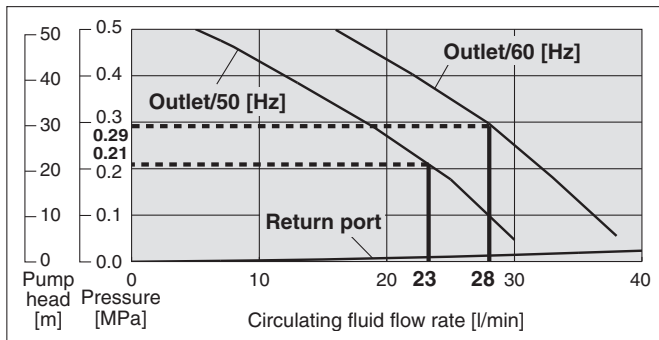

Required Facility Water Flow Rate

HRS012-W-₂₀¹⁰, HRS018-W-₂₀¹⁰, HRS024-W-20
HRS030-W-20, HRS040-W-20, HRS050-W-20
HRS060-W-20

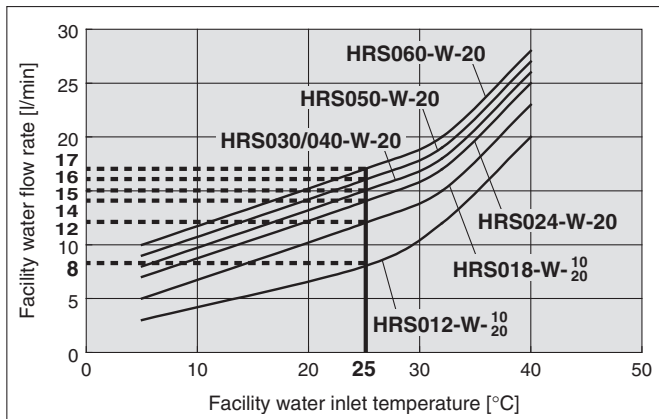

* This is the facility water flow rate at the circulating fluid rated flow and the cooling capacity listed in the "Cooling Capacity" specifications.

Caution

Mechanical Seal Pump

The pump used for the thermo-chiller HRS050/060 series uses a mechanical seal with the fixed ring and rotary ring used for the shaft seal part. If foreign matter enter the gap between the seals, this may cause a trouble such as leakage from the seal part or pump lock. Therefore, it is strongly recommended to install the particle filter in the return piping of the chiller.

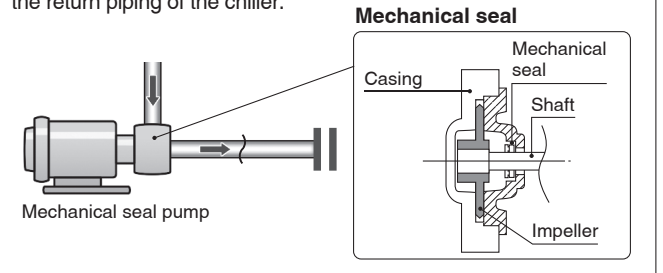

Dimensions

HRS012/018/024

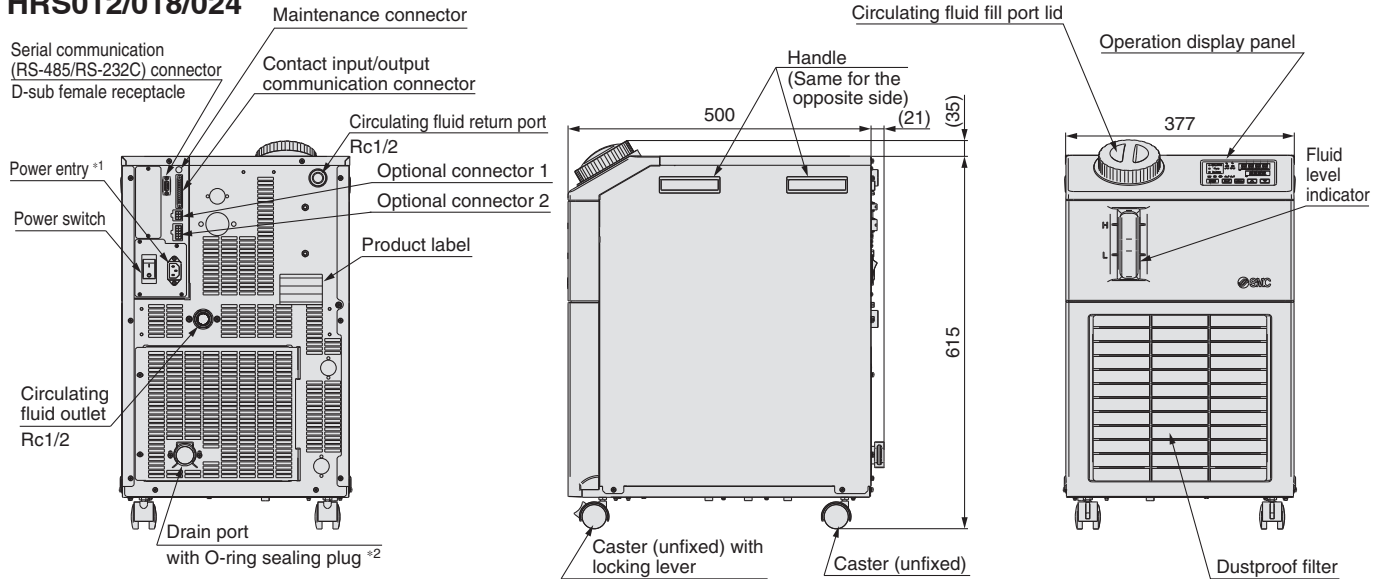

Water-cooled refrigeration

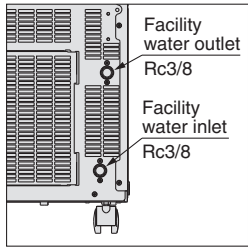

Ventilation air inlet (Air-cooled only) →

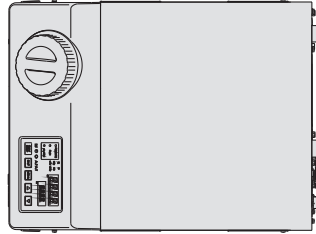

→ Ventilation air outlet (Air-cooled only)

- *1 The power supply cable is not provided. (The power supply connector is provided.)
- *2 The conversion fitting (R3/8 male thread) is provided.

HRS030-A-20

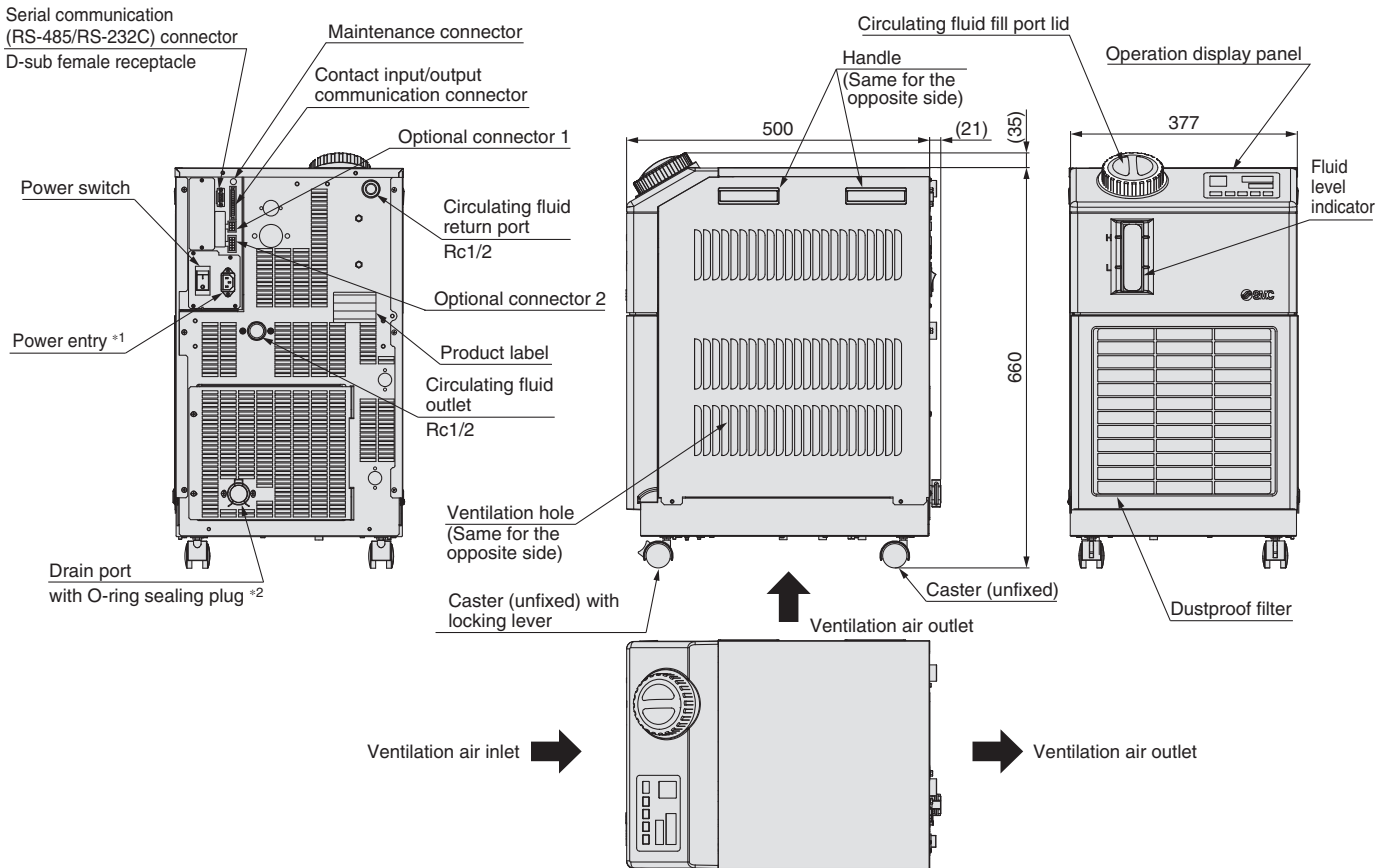

- *1 The power supply cable is not provided. (The power supply connector is provided.)
- *2 The conversion fitting (R3/8 male thread) is provided.

Dimensions

HRS030-W-20

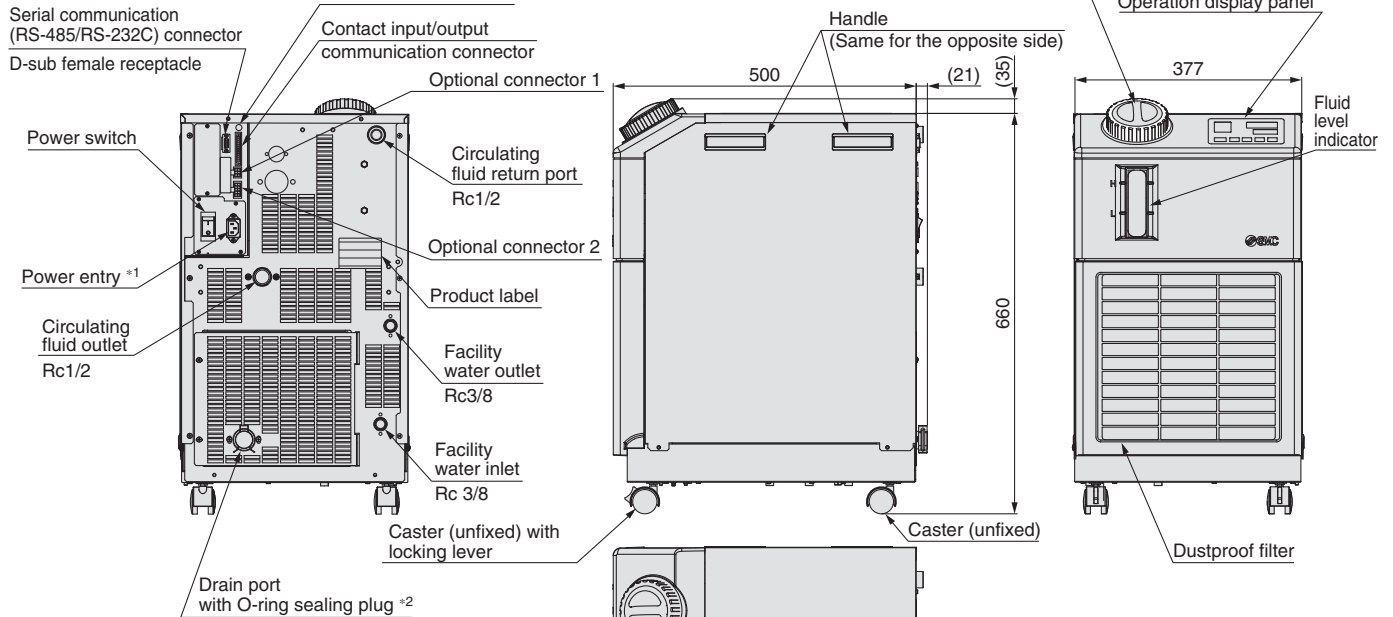

- *1 The power supply cable is not provided. (The power supply connector is provided.)
- *2 The conversion fitting (R3/8 male thread) is provided.

HRS040-A-20

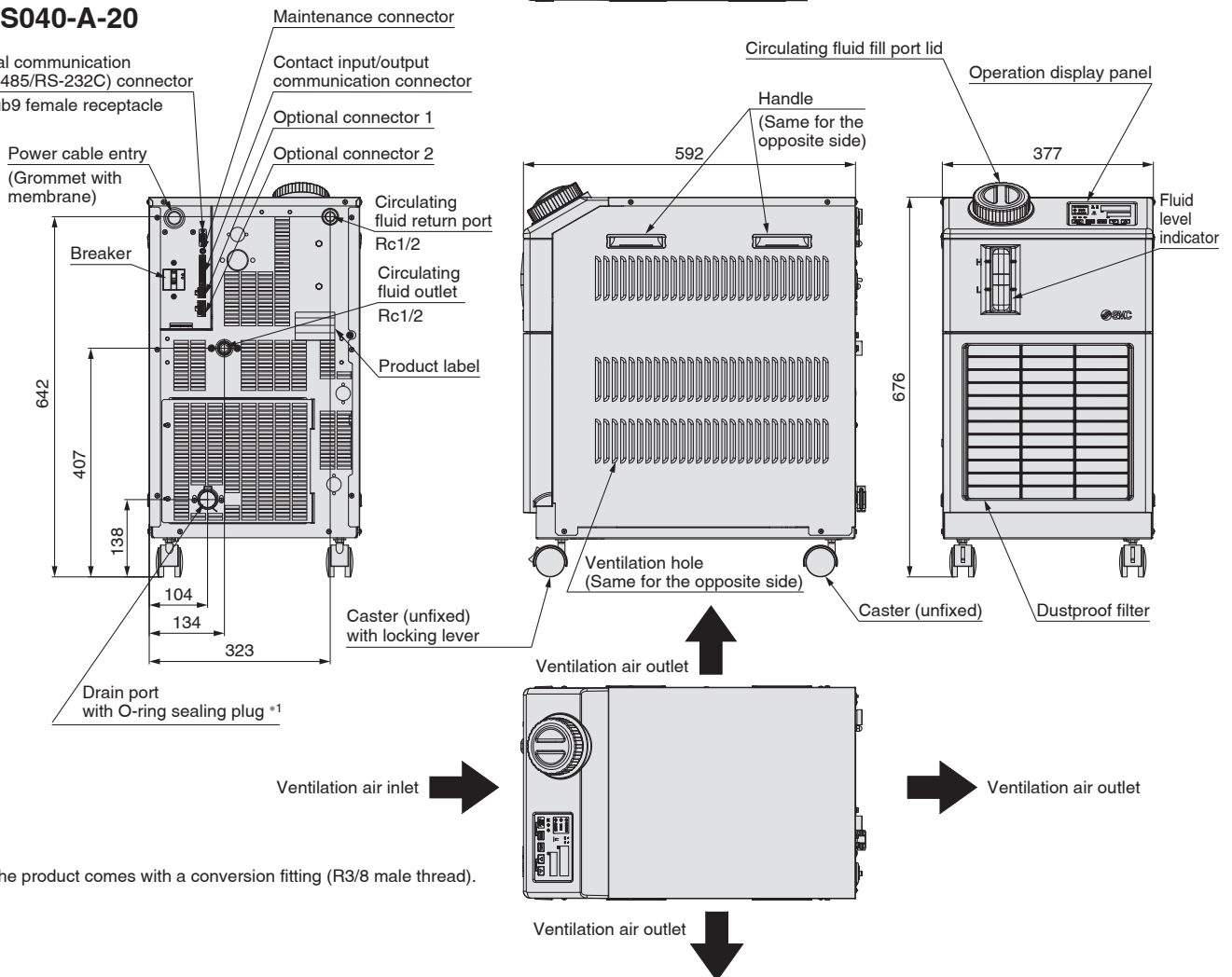

- *1 The product comes with a conversion fitting (R3/8 male thread).

Dimensions

HRS040-W-20

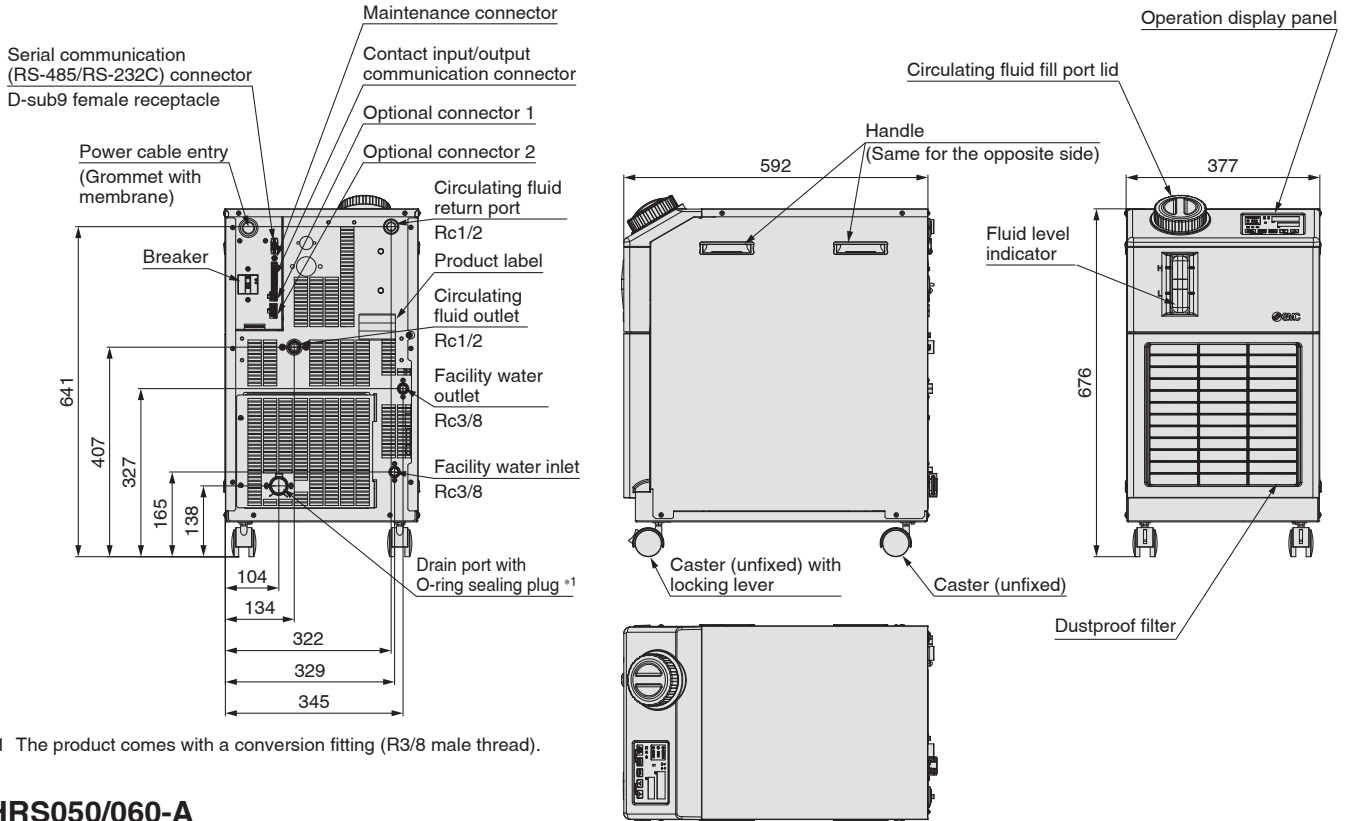

HRS050/060-A

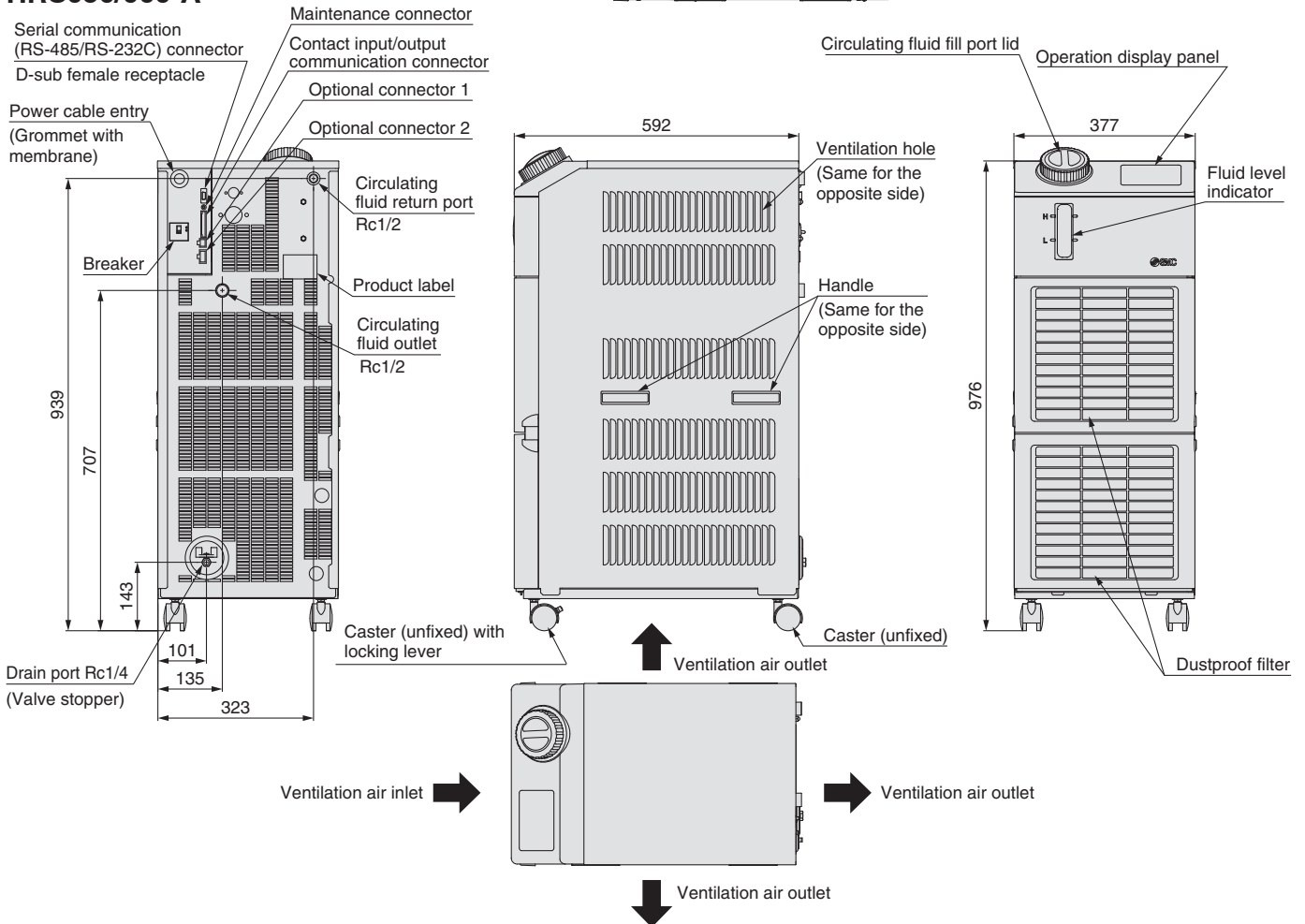

Dimensions

HRS050/060-W

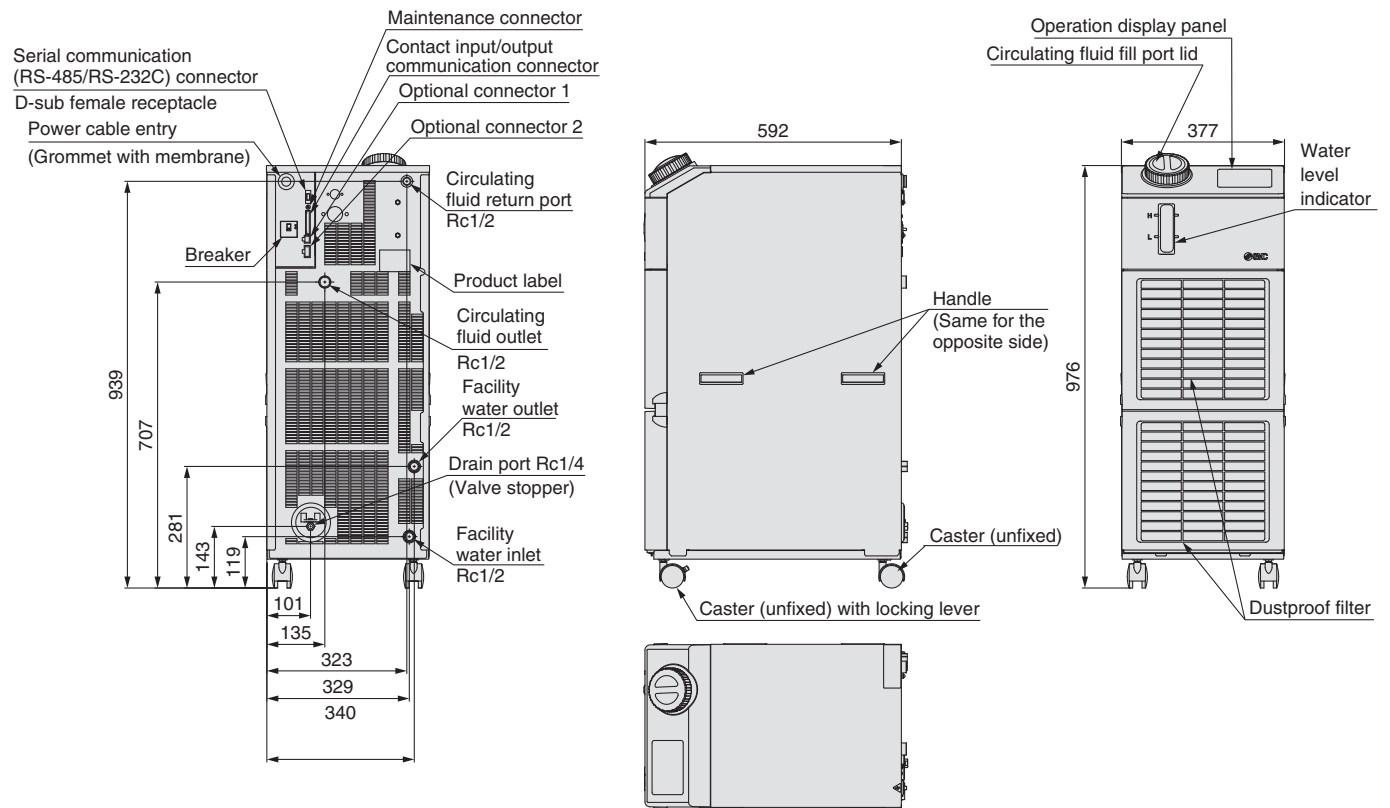

Recommended External Piping Flow

External piping circuit is recommended as shown below.

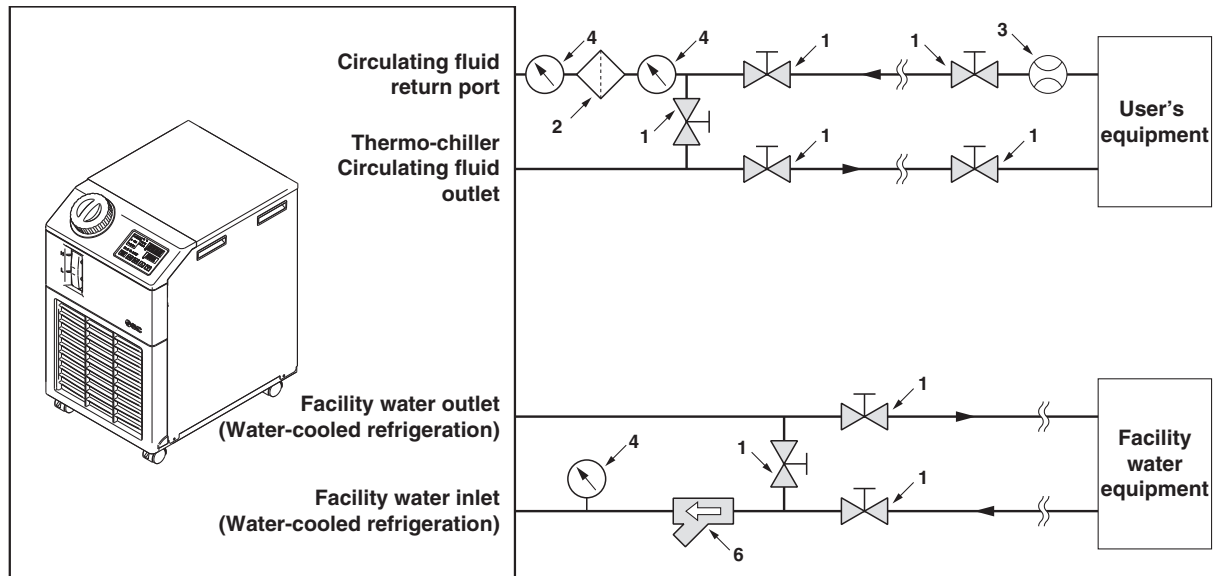

No.	Description	Size	Recommended part no.	Note
1	Valve	Rc1/2	—	—
2	Filter	Rc1/2 20 μm	HRS-PF□□□□	If foreign matter with a size of 20 μm or more are likely to enter, install the particle filter. For the recommended filter, refer to the optional accessory HRS-PF□□□□ (page 40).
3	Flow meter	0 to 50 l/min	—	—
4	Pressure gauge	0 to 1.0 MPa	—	—
5	Others (pipe, hose, etc.)	∅ 15 or more	—	—
6	Y-strainer	Rc1/2 #40	—	Install either the strainer or filter. If foreign matter with a size of 20 μm or more are likely to enter, install the particle filter.
	Filter	Rc1/2 20 μm	FQ1011N-04-T020-B-X61*1	

*1 The filter shown above cannot be directly connected to the thermo-chiller. Install it in the user's piping system.

Cable Specifications

Power Cable Specifications

Applicable model	Rated value for thermo-chiller			Power cable examples		
	Power supply	Applicable breaker rated current	Terminal block screw diameter	Cable size	Recommended crimped terminal	Optional accessories*1
HRS012-□□-10-□ HRS018-□□-10-□	Single-phase 100 VAC (50 Hz) Single-phase 100 to 115 VAC (60 Hz)	15 A	M3.5	3 cores x 2.0 mm ² (3 cores x AWG14) * Including grounding cable	—	HRS-CA001
HRS012-□□-20-□ HRS018-□□-20-□ HRS024-□□-20-□ HRS030-□□-20-□	Single-phase 200 to 230 VAC (50/60 Hz)	10 A				
HRS012-□□-20-□T HRS018-□□-20-□T HRS024-□□-20-□T HRS030-□□-20-□T		15 A				
HRS040-□□-20-□ HRS050-□□-20-□ HRS060-W□-20-□	Single-phase 200 to 230 VAC (50/60 Hz)	20 A			M4	3 cores x 3.5 mm ² (3 cores x AWG12) * Including grounding cable
HRS060-A□-20-□		30 A	3 cores x 5.5 mm ² (3 cores x AWG10) * Including grounding cable			

*1 The length of HRS-CA□□□□ is 3 m.

Operation Display Panel

The basic operation of this unit is controlled through the operation display panel on the front of the product.

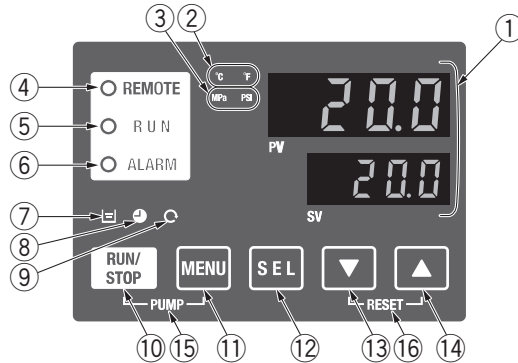

No.	Description	Function
①	Digital display (7-segment, 4 digits)	PV Displays the circulating fluid current discharge temperature and pressure and alarm codes and other menu items (codes). SV Displays the circulating fluid discharge temperature and the set values of other menus.
②	[°C] [°F] lamp	Equipped with a unit conversion function. Displays the unit of display temperature (default setting: °C).
③	[MPa] [PSI] lamp	Equipped with a unit conversion function. Displays the unit of display pressure (default setting: MPa).
④	[REMOTE] lamp	Enables remote operation (start and stop) by communication. Lights up during remote operation.
⑤	[RUN] lamp	Lights up when the product is started, and goes off when it is stopped. Flashes during stand-by for stop or anti-freezing function, or independent operation of the pump.
⑥	[ALARM] lamp	Flashes with buzzer when alarm occurs.
⑦	[L] lamp	Lights up when the surface of the fluid level indicator falls below the L level.
⑧	[C] lamp	Equipped with a timer for start and stop. Lights up when this function is operated.
⑨	[C] lamp	Equipped with a power failure auto-restart function, which restarts the product automatically after stopped due to a power failure, is provided. Lights up when this function is operated.
⑩	[RUN/STOP] key	Makes the product start or stop.
⑪	[MENU] key	Shifts the main menu (display screen of circulating fluid discharge temperature and pressure) and other menus (for monitoring and entry of set values).
⑫	[SEL] key	Changes the item in menu and enters the set value.
⑬	[▼] key	Decreases the set value.
⑭	[▲] key	Increases the set value.
⑮	[PUMP] key	Press the [MENU] and [RUN/STOP] keys simultaneously. The pump starts running independently to make the product ready for start-up (release the air).
⑯	[RESET] key	Press the [▼] and [▲] keys simultaneously. The alarm buzzer is stopped and the [ALARM] indicator is reset.

Alarm

This unit has 35 types of alarms as standard, and displays each of them by its alarm code on the PV screen with the [ALARM] lamp ([LOW LEVEL] lamp) lit up on the operation display panel. The alarm can be read out through communication.

Alarm code	Alarm message	Operation status	Alarm code	Alarm message	Operation status
AL01	Low level in tank	Stop*1	AL20	Memory error	Stop
AL02	High circulating fluid discharge temperature	Stop	AL21	DC line fuse cut	Stop
AL03	Circulating fluid discharge temperature rise	Continue*1	AL22	Circulating fluid discharge temperature sensor failure	Stop
AL04	Circulating fluid discharge temperature drop	Continue*1	AL23	Circulating fluid return temperature sensor failure	Stop
AL05	High circulating fluid return temperature (60 °C)	Stop	AL24	Compressor intake temperature sensor failure	Stop
AL06	High circulating fluid discharge pressure	Stop	AL25	Circulating fluid discharge pressure sensor failure	Stop
AL07	Abnormal pump operation	Stop	AL26	Compressor discharge pressure sensor failure	Stop
AL08	Circulating fluid discharge pressure rise	Continue*1	AL27	Compressor intake pressure sensor failure	Stop
AL09	Circulating fluid discharge pressure drop	Continue*1	AL28	Pump maintenance	Continue
AL10	High compressor intake temperature	Stop	AL29	Fan motor maintenance*3	Continue
AL11	Low compressor intake temperature	Stop	AL30	Compressor maintenance	Continue
AL12	Low super heat temperature	Stop	AL31*2	Contact 1 input signal detection	Stop*1
AL13	High compressor discharge pressure	Stop	AL32*2	Contact 2 inputs signal detection	Stop*1
AL15	Refrigerating circuit pressure (high pressure side) drop	Stop	AL33*4	Water leakage	Stop*1
AL16	Refrigerating circuit pressure (low pressure side) rise	Stop	AL34*4	Electric resistance rise	Continue
AL17	Refrigerating circuit pressure (low pressure side) drop	Stop	AL35*4	Electric resistance drop	Continue
AL18	Compressor overload	Stop	AL36*4	Electric resistance sensor failure	Continue
AL19*2	Communication error*2	Continue*1			

*1 "Stop" or "Continue" are default settings. Users can change them to "Continue" and "Stop". For details, refer to the Operation Manual.

*2 "AL19, AL31, AL32" are disabled in the default setting. If this function is necessary, it should be set by the user, referring to the Operation Manual.

*3 For water-cooled models, the alarm is not activated.

*4 This alarm function can be used when the option (sold separately) is used.

Please download the Operation Manual via our website, <https://www.smc.eu>

Communication Functions

Contact Input/Output

Item	Specifications	
Connector type (to the product/to the socket (Accessory))	MC1,5/12-GF-3,5 / MC1,5/12-STF-3,5 (made by PHOENIX CONTACT)	
Input signal	Insulation method	Photocoupler
	Rated input voltage	24 VDC
	Operating voltage range	21.6 VDC to 26.4 VDC
	Rated input current	5 mA TYP
	Input impedance	4.7 kΩ
Contact output signal	Rated load voltage	48 VAC or less/30 VDC or less
	Maximum load current	500 mA AC/DC (Resistance load)
	Minimum load current	5 VDC 10 mA
Output voltage	24 VDC ±10 % 0.5 A MAX	
Circuit diagram		

*1 The pin numbers and output signals can be set by the user. For details, refer to the Operation Manual.

*2 When using with optional accessories, depending on the accessory, the allowable current of 24 VDC devices will be reduced. Refer to the operation manual of the optional accessories for details.

Serial Communication

The serial communication (RS-485/RS-232C) enables the following items to be written and read out.

For details, refer to the Operation Manual for communication.

Writing	Readout
Run/Stop Circulating fluid temperature setting (SV)	Circulating fluid present temperature Circulating fluid discharge pressure Electric resistance *1 Status information Alarm occurrence information

*1 When the optional accessory, "electric resistance sensor set" is used.

Item	Specifications
Connector type	D-sub 9-pin, Female connector (Mounting screw: M2.6 x 0.45)
Protocol	Modicon Modbus compliant/Simple communication protocol
Standards	EIA standard RS-485 EIA standard RS-232C
Circuit diagram	

* The terminal resistance of RS-485 (120 Ω) can be switched by the operation display panel. For details, refer to the Operation Manual. Do not connect other than in the way shown above, as it can result in failure.

Please download the Operation Manual via our website, <https://www.smc.eu>

HRS Series Options

* Options have to be selected when ordering the thermo-chiller. It is not possible to add them after purchasing the unit.

B Option symbol

With Earth Leakage Breaker

HRS - - - **B**

● With earth leakage breaker

Earth leakage breaker

In the event of a short circuit, overcurrent or overheating, the earth leakage breaker will automatically shut off the power supply.

Applicable model	HRS012/018- <input type="checkbox"/> <input type="checkbox"/> -10-B	HRS012/018/024/030- <input type="checkbox"/> <input type="checkbox"/> -20-B	HRS040- <input type="checkbox"/> <input type="checkbox"/> -20-B HRS050- <input type="checkbox"/> <input type="checkbox"/> -20-B HRS060-W <input type="checkbox"/> <input type="checkbox"/> -20-B	HRS060-A <input type="checkbox"/> <input type="checkbox"/> -20-B
Rated current sensitivity [mA]	30	30	30	30
Rated shutdown current [A]	15	10	20	30
Short circuit display method	Mechanical button			

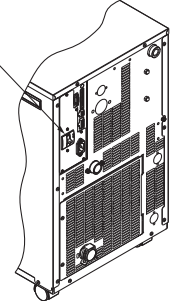

J Option symbol

With Automatic Fluid Fill Function

HRS - - - **J**

● With automatic fluid fill function

Automatic fluid fill port Rc3/8

Overflow port Rc3/4

By installing this at the automatic fluid fill port, the circulating fluid can be automatically supplied to the product using a built-in solenoid valve for a fluid fill while the circulating fluid is decreasing.

Applicable model	HRS012/018/024/030/040/050/060- <input type="checkbox"/> <input type="checkbox"/> - J
Fluid fill method	Built-in solenoid valve for automatic fluid fill
Fluid fill pressure [MPa]	0.2 to 0.5

* When the option, with automatic fluid fill function, is selected, the weight increases by 1 kg.

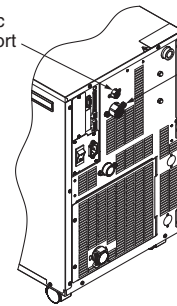

M Option symbol

Applicable to Deionised Water Piping

HRS - - - **M**

● Applicable to deionised water piping

Contact material of the circulating fluid circuit is made from non-copper materials. Select this when using deionised water with a resistance of 1 MΩ·cm or more (1 μs/cm or less).

Applicable model	HRS012/018/024/030/040/050/060- <input type="checkbox"/> <input type="checkbox"/> - M
Contact material for circulating fluid	Stainless steel (including heat exchanger brazing), Alumina ceramic, SiC, Carbon, PP, PE, POM, FKM, NBR, EPDM, PVC

* No change in external dimensions

T Option symbol

High-Pressure Pump Mounted

HRS - - - **T /MT**

● High-pressure pump mounted

Possible to choose a high-pressure pump in accordance with user's piping resistance. Cooling capacity will decrease by heat generated in the pump.

* The HRS050/060 cannot be selected.

Applicable model		HRS012/018- <input type="checkbox"/> <input type="checkbox"/> -10-T/MT	HRS012/018/024/030- <input type="checkbox"/> <input type="checkbox"/> -20-T	HRS012/018/024/030- <input type="checkbox"/> <input type="checkbox"/> -20-MT*1	HRS040- <input type="checkbox"/> <input type="checkbox"/> -20-T/MT	
Pump	Rated flow (50/60 Hz)*2,3	l/min	7 (0.36 MPa)/10 (0.42 MPa)	10 (0.44 MPa)/14 (0.40 MPa)	10 (0.32 MPa)/14 (0.32 MPa)	23 (0.18 MPa)/28 (0.23 MPa)
	Maximum flow rate (50/60 Hz)	l/min	18/22			
	Maximum pump head (50/60 Hz)	m	55	70	60	50
	Output	W	320	550		
Circuit protector	A	15	15 (10 A for standard)		20	
Recommended earth leakage breaker capacity	A	15			20	
Cooling capacity*4	W	The cooling capacity reduces about 300 W from the value in the catalogue. (due to an increase in the heat generation of the pump)				

*1 -MT: Applicable to deionised water piping + High-pressure pump

*2 The capacity at the thermo-chiller outlet when the circulating fluid temperature is 20 °C.

*3 Required minimum flow rate for maintaining the cooling capacity or temperature stability

*4 Cooling capacity will decrease as pump power increases.

* When the option, high-pressure pump mounted, is selected, the weight increases by 4 kg for -10 type and 6 kg for -20 type.

* No change in external dimensions

Pump Capacity

HRS012/018-□□-10-T/MT

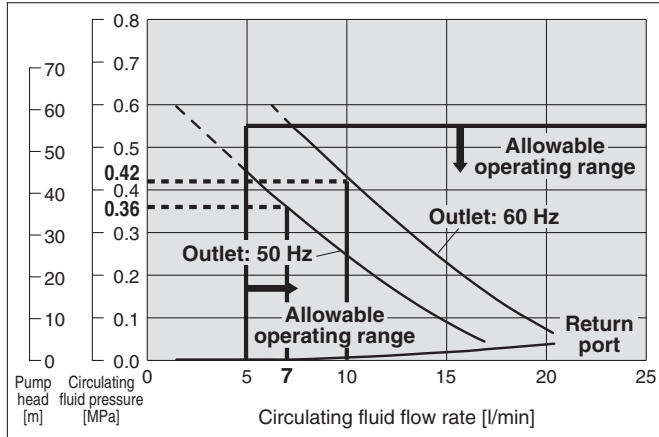

HRS012/018/024-□□-20-T

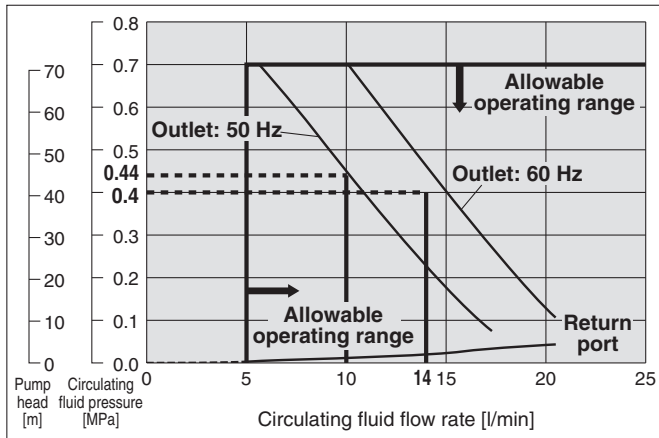

HRS030-□□-20-T

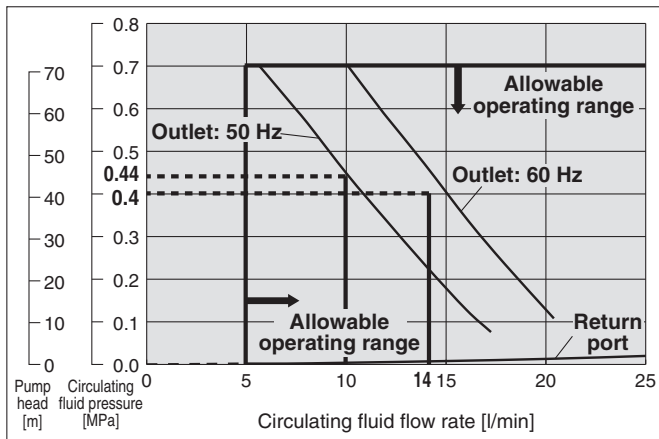

HRS040-□□-20-T/MT

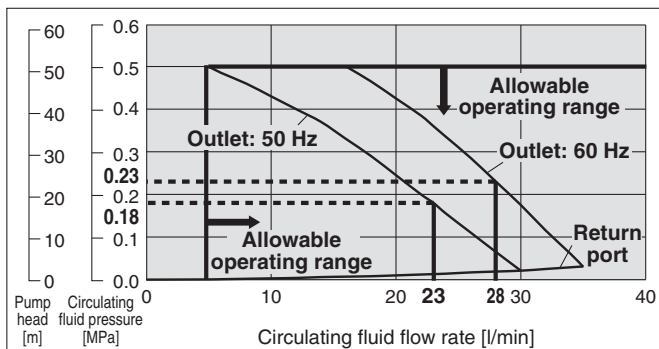

Caution

Mechanical Seal Pump

The pump used for the option T/MT of the thermo-chiller HRS 0 1 2 to 040 uses a mechanical seal with the fixed ring and rotary ring used for the shaft seal part. If foreign matter enter the gap between the seals, this may cause a trouble such as leakage from the seal part or pump lock. Therefore, it is strongly recommended to install the particle filter in the return piping of the chiller.

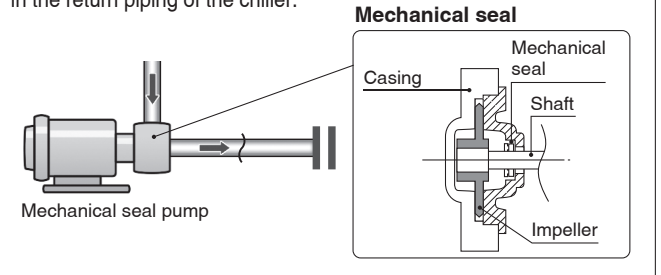

HRS012/018/024-□□-20-MT

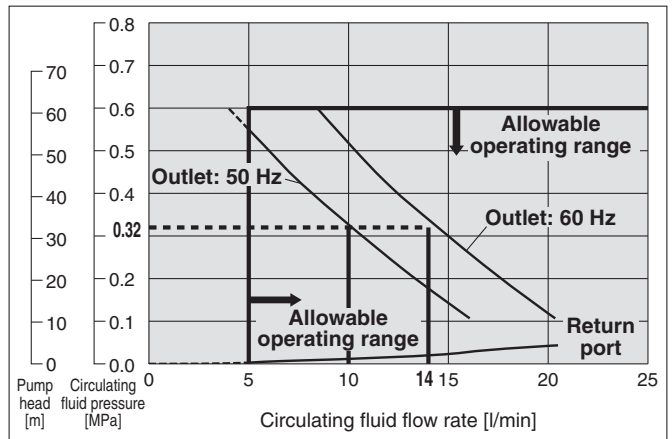

HRS030-□□-20-MT

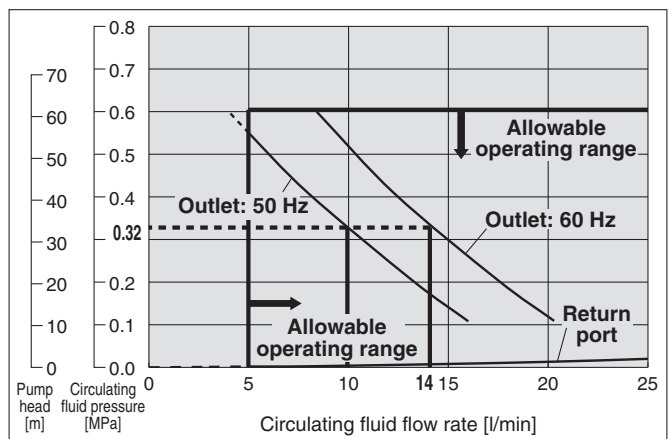

* Options have to be selected when ordering the thermo-chiller. It is not possible to add them after purchasing the unit.

W Option symbol SI Unit Only

HRS [] - [] - [] - [] - W

● SI unit only

The circulating fluid temperature and pressure are displayed in SI units [MPa/°C] only. If this option is not selected, a product with a unit selection function will be provided by default.
* No change in external dimensions

G Option symbol High-Temperature Environment Specification

HRS [] - A [] - 20 - G

● High-temperature environment specification

Applicable model	HRS012/018/024-A□-20-G
Cooling method	Air-cooled refrigeration
Power supply	Single-phase 200 to 230 VAC (50/60 Hz)

* No change in external dimensions

* The HRS030/040/050/060 cannot be selected.

This product makes use at ambient temperatures of up to 45 °C possible. Also increases cooling capacity at ambient temperature of 32 °C. (Cooling capacity is equal to standard products at ambient temperatures of less than 32 °C.)

* Ventilation slots are added to thermo-chiller side panels. For this reason, please provide 300 mm of ventilation space next to the side panels (do not install with sides touching walls).

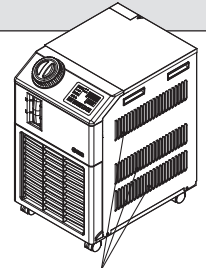

Ventilation slots are added to side panels (on both sides).

* If the product is used at altitude of 1000 m or higher, refer to "Operating Environment/Storage Environment" (page 48) Item 14 "* For altitude of 1000 m or higher."

* For models with high-pressure pump mounted (-T), the cooling capacity will decrease by about 300 W from each graph.

Cooling Capacity

HRS012-A□-20-G

(50 Hz)

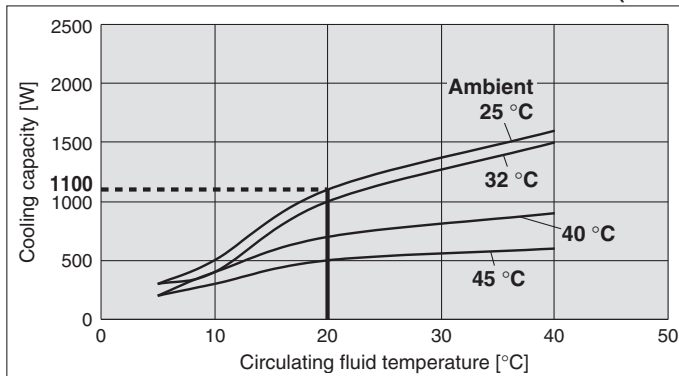

(60 Hz)

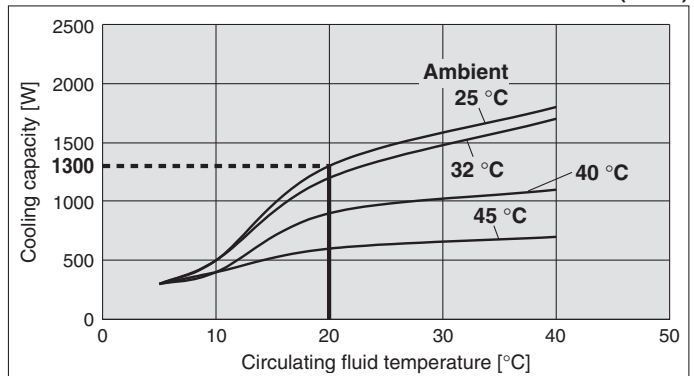

HRS018-A□-20-G

(50 Hz)

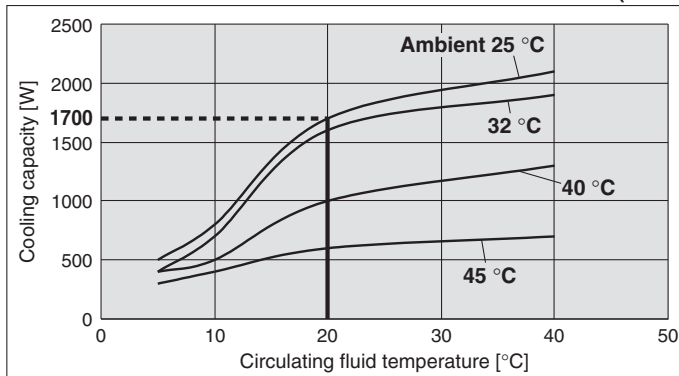

(60 Hz)

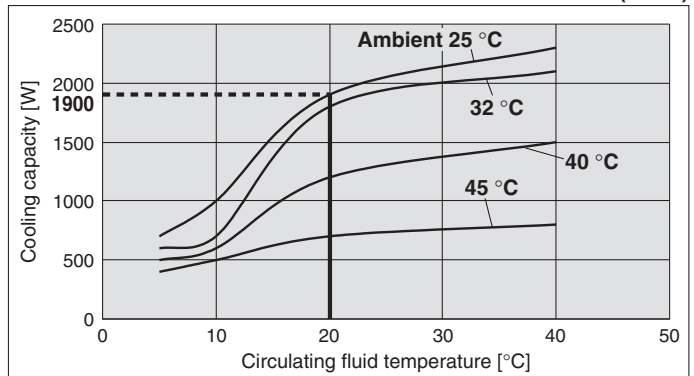

HRS024-A□-20-G

(50 Hz)

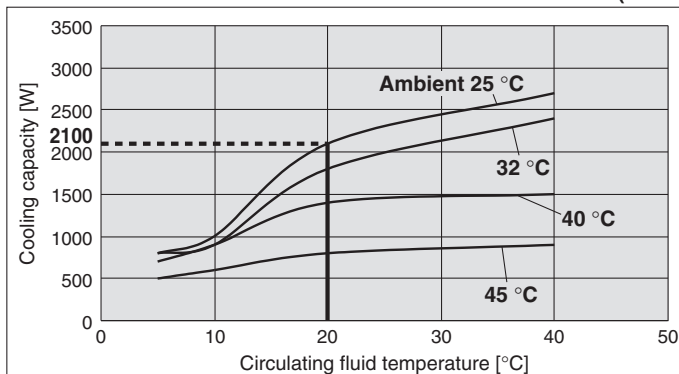

(60 Hz)

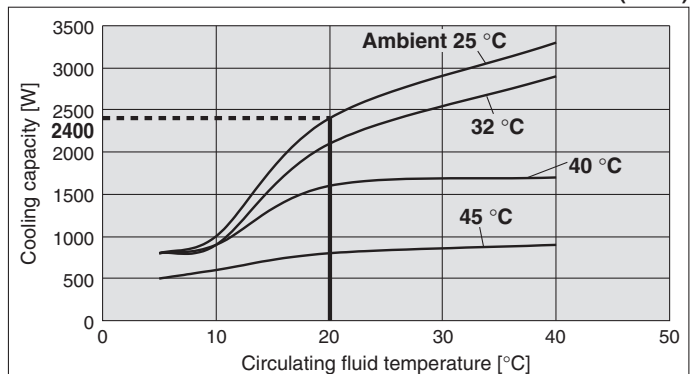

HRS Series

Optional Accessories

Applicable Model List/Air-Cooled Refrigeration

● Optional accessories applicable to this model
★ Optional accessories recommended to be used for this model

No.	Description	Part no.	HRS012-A HRS018-A		HRS024-A-20	HRS030-A-20	HRS040-A-20	HRS050-A-20 HRS060-A-20		Option		Page
			-10	-20				(for -J)	(for -T)			
①	Anti-quake bracket	HRS-TK001	●	●	●	●	—	—	—	—	—	33
		HRS-TK002	—	—	—	—	●	●	—	—	—	
②	Piping conversion fitting (for air-cooled refrigeration)	G thread conversion fitting set	HRS-EP001	●	●	●	●	●	—	—	—	33
		NPT thread conversion fitting set	HRS-EP002	●	●	●	●	●	—	—	—	
		G thread conversion fitting set	HRS-EP009	—	—	—	—	—	●	—	—	
		NPT thread conversion fitting set	HRS-EP010	—	—	—	—	—	●	—	—	
③	Piping conversion fitting*1 (for automatic fluid fill port)	G thread conversion fitting set	HRS-EP005	—	—	—	—	—	—	●	—	34
		NPT thread conversion fitting set	HRS-EP006	—	—	—	—	—	—	●	—	
	Piping conversion fitting*2 (for drain outlet)	G thread conversion fitting set	HRS-EP007	—	—	—	—	—	—	—	●	
		NPT thread conversion fitting set	HRS-EP008	—	—	—	—	—	—	—	●	
④	Concentration meter	HRZ-BR002	●	●	●	●	●	●	●	●	35	
⑤	Bypass piping set	HRS-BP001	●	●	●	●	—	—	—	—	—	35
		HRS-BP004	—	—	—	—	●	●	—	—	—	
⑥	Power supply cable	For single-phase 100/115 VAC type	HRS-CA001	●	—	—	—	—	—	—	—	36
		For single-phase 200 VAC type	HRS-CA002	—	●	●	●	—*3	—*3	—	—	
		For single-phase 100/115 VAC type	HRS-CA003	●	—	—	—	—	—	—	—	
		For single-phase 200 VAC type	HRS-CA004	—	—	—	—	●	●*4	—	—	
	Retaining clip	HRS-S0074	●	●	●	●	—	—	—	—	—	
⑦	DI filter set	HRS-DP001	●	●	●	●	●	●	—	—	37	
		HRS-DP002	●	●	●	●	●	●	—	—		
⑧	Electric resistance sensor set	HRS-DI001	●	●	●	●	●	●	—	—	38	
		With control function/bypass	HRS-DI003	●	●	●	●	●	—	—		
	Electric resistance control set	With bypass	HRS-DI004	●	●	●	●	●	—	—		
		With control function	HRS-DI005	●	●	●	●	●	—	—		
⑨	Electric conductivity sensor set	HRS-DI008	●	●	●	●	●	●	—	—	39	
		With control function/bypass	HRS-DI009	●	●	●	●	—	—	—		
	Electric conductivity control set	With control function	HRS-DI011	●	●	●	●	●	—	—		
⑩	Particle filter set	(#5) OUT side	HRS-PF001	●	●	●	●	●	—	—	40	
		(#10) OUT side	HRS-PF002	—	—	—	—	—	●	—		
		(#5) IN side	HRS-PF003	●	●	●	●	●	★	—		★
		(#10) IN side	HRS-PF004	—	—	—	—	—	★	—		★
⑪	Drain pan set	With water leakage sensor	HRS-WL001	●	●	●	●	—	—	—	41	
			HRS-WL002	—	—	—	—	●	●	—		—
⑫	Connector cover	HRS-BK001	●	●	●	●	—	—	—	—	42	
		HRS-BK002	—	—	—	—	●	●	—	—		
⑬	Analogue gateway unit	HRS-CV001	●	●	●	●	●	●	—	—	42	
⑭	Replacement type dustproof filter set	HRS-FL001	●	●	●	—	—	—	—	—	42	
	Replacement type dustproof filter	HRS-FL002	●	●	●	—	—	—	—	—		
⑮	Separately-installed*5 power transformer	IDF-TR1000-1	●	—	—	—	—*3	—	—	—	—	43
		IDF-TR1000-2	●	—	—	—						
		IDF-TR1000-3	●	—	—	—						
		IDF-TR1000-4	●	—	—	—						
		IDF-TR2000-9	—	●	●	●						
		IDF-TR2000-10	—	●	●	●						
		IDF-TR2000-11	—	●	●	●						
⑯	Filter for circulating fluid fill port	HRS-PF007	●	●	●	●	●	●	●	●	44	

*1 When option J is selected.
 *2 When option T or the HRS050/060 is selected.
 *3 For the HRS040/050/060 models: To be prepared by the user.
 *4 Not applicable for the HRS060-A□-20. To be prepared by the user.
 *5 This product does not have CE/UKCA marking and is not compliant with UL standards.

Applicable Model List/Water-Cooled Refrigeration

● Optional accessories applicable to this model
★ Optional accessories recommended to be used for this model

No.	Description	Part no.	HRS012-W HRS018-W		HRS024-W-20	HRS030-W-20	HRS040-W-20	HRS050-W-20 HRS060-W-20		Option		Page
			-10	-20				(for -J)	(for -T)			
①	Anti-quake bracket	HRS-TK001	●	●	●	●	—	—	—	—	—	33
		HRS-TK002	—	—	—	—	●	●	—	—	—	
②	Piping conversion fitting (for water-cooled refrigeration)	G thread conversion fitting set	HRS-EP003	●	●	●	●	●	—	—	—	34
		NPT thread conversion fitting set	HRS-EP004	●	●	●	●	●	—	—	—	
		G thread conversion fitting set	HRS-EP011	—	—	—	—	—	●	—	—	
		NPT thread conversion fitting set	HRS-EP012	—	—	—	—	—	●	—	—	
③	Piping conversion fitting*1 (for automatic fluid fill port)	G thread conversion fitting set	HRS-EP005	—	—	—	—	—	●	●	—	34
		NPT thread conversion fitting set	HRS-EP006	—	—	—	—	—	●	●	—	
	Piping conversion fitting*2 (for drain outlet)	G thread conversion fitting set	HRS-EP007	—	—	—	—	—	—	—	●	
		NPT thread conversion fitting set	HRS-EP008	—	—	—	—	—	—	—	●	
④	Concentration meter	HRZ-BR002	●	●	●	●	●	●	●	●	35	
⑤	Bypass piping set	HRS-BP001	●	●	●	●	—	—	—	—	35	
		HRS-BP004	—	—	—	—	●	●	—	—		
⑥	Power supply cable	For single-phase 100/115 VAC type	HRS-CA001	●	—	—	—	—	—	—	36	
		For single-phase 200 VAC type	HRS-CA002	—	●	●	●	—*3	—*3	—		
		For single-phase 100/115 VAC type	HRS-CA003	●	—	—	—	—	—	—		
		For single-phase 200 VAC type	HRS-CA004	—	—	—	—	●	●*4	—		
	Retaining clip	HRS-S0074	●	●	●	●	—	—	—	—		
⑦	DI filter set	HRS-DP001	●	●	●	●	●	●	—	—	37	
		HRS-DP002	●	●	●	●	●	●	—	—		
⑧	Electric resistance sensor set	HRS-DI001	●	●	●	●	●	●	—	—	38	
		With control function/bypass	HRS-DI003	●	●	●	●	●	—	—		
	Electric resistance control set	With bypass	HRS-DI004	●	●	●	●	●	—	—		
		With control function	HRS-DI005	●	●	●	●	●	—	—		
⑨	Electric conductivity sensor set	HRS-DI008	●	●	●	●	●	●	—	—	39	
		With control function/bypass	HRS-DI009	●	●	●	●	—	—	—		
	Electric conductivity control set	With control function	HRS-DI011	●	●	●	●	●	—	—		
⑩	Particle filter set	(#5) OUT side	HRS-PF001	●	●	●	●	●	—	—	40	
		(#10) OUT side	HRS-PF002	—	—	—	—	—	●	—		
		(#5) IN side	HRS-PF003	●	●	●	●	●	★	—		★
		(#10) IN side	HRS-PF004	—	—	—	—	—	★	—		★
⑪	Drain pan set	With water leakage sensor	HRS-WL001	●	●	●	●	—	—	—	41	
			HRS-WL002	—	—	—	—	●	●	—		—
⑫	Connector cover	HRS-BK001	●	●	●	●	—	—	—	—	42	
		HRS-BK002	—	—	—	—	●	●	—	—		
⑬	Analogue gateway unit	HRS-CV001	●	●	●	●	●	●	—	—	42	
⑭	Replacement type dustproof filter set	—	—	—	—	—	—	—	—	—	—	
	Replacement type dustproof filter	—	—	—	—	—	—	—	—	—		
⑮	Separately-installed*5 power transformer	IDF-TR1000-1	●	—	—	—	—*3	—	—	—	—	43
		IDF-TR1000-2	●	—	—	—						
		IDF-TR1000-3	●	—	—	—						
		IDF-TR1000-4	●	—	—	—						
		IDF-TR2000-9	—	●	●	●						
		IDF-TR2000-10	—	●	●	●						
IDF-TR2000-11	—	●	●	●								
⑯	Filter for circulating fluid fill port	HRS-PF007	●	●	●	●	●	●	●	●	44	

*1 When option J is selected.
 *2 When option T or the HRS050/060 is selected.
 *3 For the HRS040/050/060 models: To be prepared by the user.
 *4 Not applicable for the HRS060-A□-20. To be prepared by the user.
 *5 This product does not have CE/UKCA marking and is not compliant with UL standards.

HRS Series

① Anti-Quake Bracket

This bracket can be used to reduce product damage in the case of an earthquake. An anchor bolt (M 8) suitable for the flooring material should be prepared separately by the user. (Anti-quake bracket thickness: 1.6 mm)

[mm]			
Part no. (per unit)	Applicable model	A	B
HRS-TK001	HRS012-□□-□	555	(590)
	HRS018-□□-□		
	HRS024-□□-□		
HRS-TK002	HRS030-□□-□	546	(581)
	HRS040-□□-□	630	(675)
	HRS050-□□-□	664	(698)
	HRS060-□□-□		

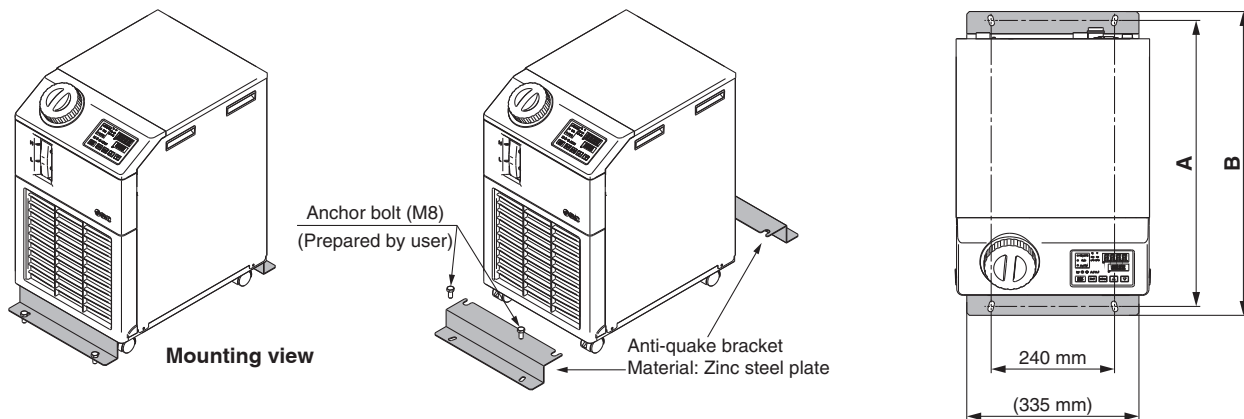

② Piping Conversion Fitting (For Air-Cooled Refrigeration)

■ Conversion fitting for circulating fluid + Conversion fitting for drain outlet HRS012-A□-□, HRS018-A□-□, HRS024-A□-□, HRS030-A□-□, HRS040-A□-□

This fitting changes the port size for circulating fluid from Rc 1/2 to G1/2 or NPT1/2, and for drain from Rc3/8 to G3/8 or NPT3/8. It is not necessary to purchase this when pipe thread type F or N is selected in "How to Order" since it is included in the product.

Part no.	Applicable model
HRS-EP001	G thread conversion fitting set
	HRS012-A-□
	HRS018-A-□
HRS-EP002	NPT thread conversion fitting set
	HRS024-A-□
	HRS030-A-□
HRS040-A-□	

When the options, with automatic fluid fill function "-J", or high-pressure pump mounted "-T" are selected, purchase ③ piping conversion fitting (for option), too.

HRS050-A□-□, HRS060-A□-□

This fitting changes the port size for circulating fluid from Rc1/2 to G1/2 or NPT1/2, and for drain from Rc1/4 to G1/4 or NPT1/4. It is not necessary to purchase this when pipe thread type F or N is selected in "How to Order" since it is included in the product.

Part no.	Applicable model
HRS-EP009	G thread conversion fitting set
	HRS050-A-□
HRS-EP010	NPT thread conversion fitting set
	HRS060-A-□

When the option, with automatic fluid fill function "-J", is selected, purchase ③ piping conversion fitting (for option), too.

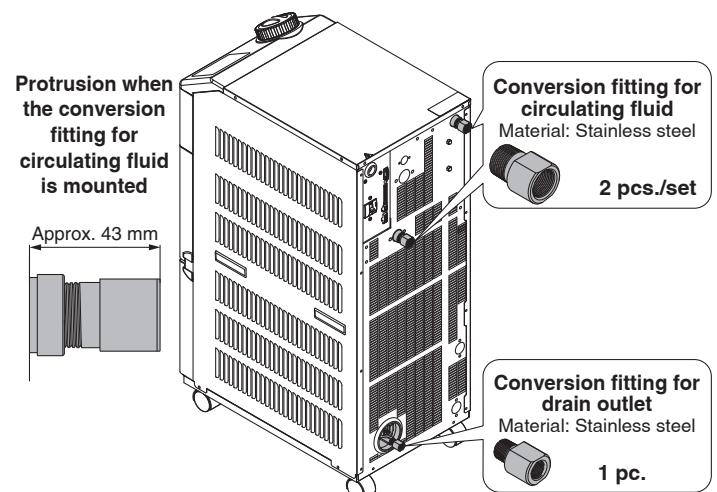
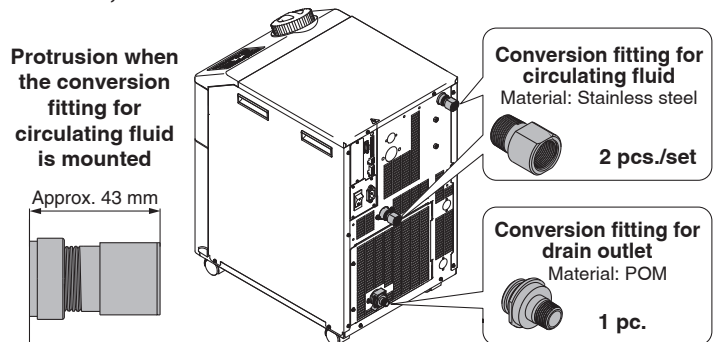

② Piping Conversion Fitting (For Water-Cooled Refrigeration)

■ Conversion fitting for circulating fluid + Conversion fitting for facility water + Conversion fitting for drain outlet HRS012-W□-□, HRS018-W□-□, HRS024-W□-□, HRS030-W□-□, HRS040-W□-□

This fitting changes the port size for circulating fluid from Rc1/2 to G1/2 or NPT1/2, for facility water from Rc3/8 to G3/8 or NPT3/8, and for drain from Rc3/8 to G3/8 or NPT3/8. It is not necessary to purchase this when pipe thread type F or N is selected in "How to Order" since it is included in the product.

Part no.	Applicable model
HRS-EP003	G thread conversion fitting set
HRS-EP004	NPT thread conversion fitting set

When the options, with automatic fluid fill function "J", or high-pressure pump mounted "T" are selected, purchase ③ piping conversion fitting (for option), too.

HRS050-W□-□, HRS060-W□-□

This fitting changes the port size for circulating fluid or facility water from Rc1/2 to G1/2 or NPT1/2 and for drain from Rc1/4 to G1/4 or NPT1/4.

It is not necessary to purchase this when pipe thread type F or N is selected in "How to Order" since it is included in the product.

Part no.	Applicable model
HRS-EP011	G thread conversion fitting set
HRS-EP012	NPT thread conversion fitting set

When the option, with automatic fluid fill function "J", is selected, purchase ③ piping conversion fitting (for option), too.

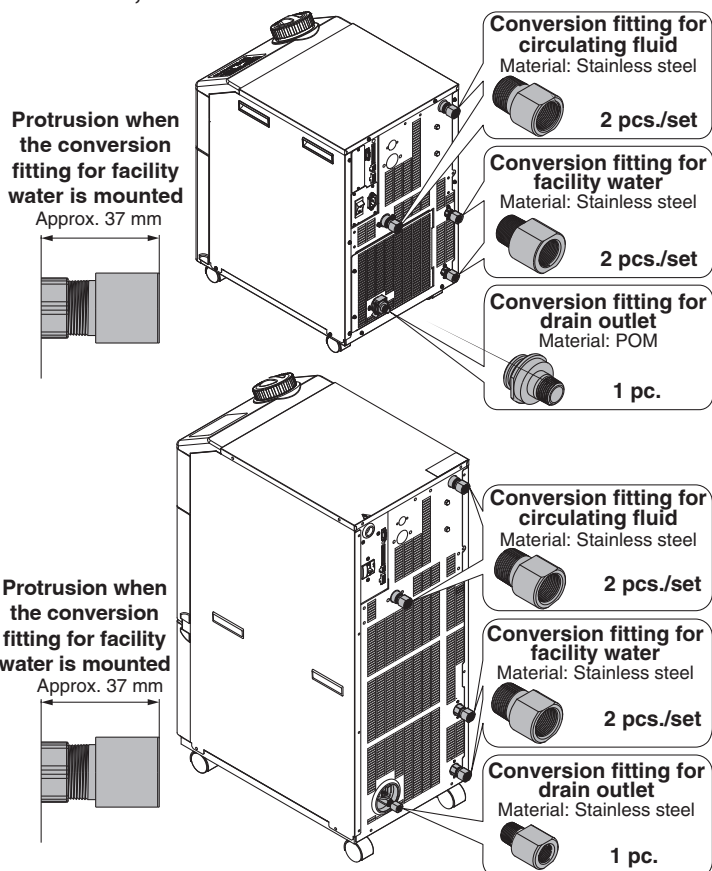

③ Piping Conversion Fitting (For Option)

■ Conversion fitting for automatic fluid fill port

This fitting changes the port size for the option, with automatic fluid fill function "J" from Rc3/8, Rc3/4 to G3/8, G3/4 or NPT3/8, NPT3/4.

It is not necessary to purchase this when pipe thread type F or N is selected in "How to Order" since it is included in the product.

Part no.	Applicable model
HRS-EP005	G thread conversion fitting set
HRS-EP006	NPT thread conversion fitting set

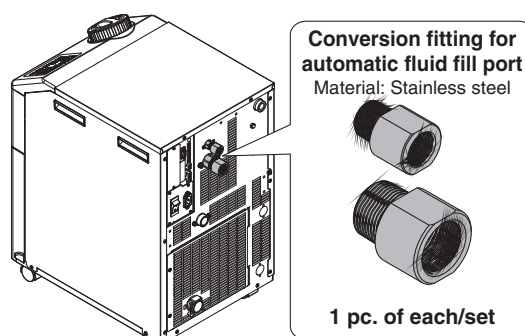

■ Conversion fitting for drain outlet

This fitting changes the port size for drain outlet for the option, high-pressure pump mounted "T" from Rc1/4 to G1/4 or NPT1/4. It is not necessary to purchase this when pipe thread type F or N is selected in "How to Order" since it is included in the product.

Part no.	Applicable model
HRS-EP007	G thread conversion fitting
HRS-EP008	NPT thread conversion fitting

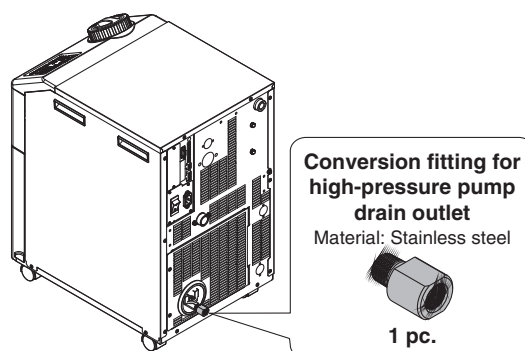

*1 It is not necessary to purchase this when you purchase the HRS-EP009 to 012 since it is included in the product.

HRS Series

④ Concentration Meter

This meter can be used to control the concentration of ethylene glycol aqueous solution regularly.

Part no.	Applicable model
HRZ-BR002	HRS012-□□-□
	HRS018-□□-□
	HRS024-□□-□
	HRS030-□□-□
	HRS040-□□-□
	HRS050-□□-□
	HRS060-□□-□

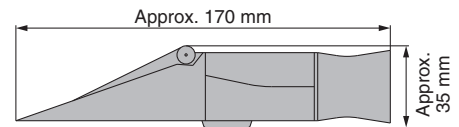

⑤ Bypass Piping Set

When the circulating fluid goes below the rated flow (7 l/min for the HRS012, 018, 024, 030 and 23/28 l/min for the HRS040, 050, 060), cooling capacity will be reduced and the temperature stability will be badly affected. In such a case, use the bypass piping set. A high-pressure pump is also available.

Part no.	Applicable model
HRS-BP001	HRS012-□□-□
	HRS018-□□-□
	HRS024-□□-□
	HRS030-□□-□
	HRS030-□□-□

Parts List

No.	Description	Fluid contact material	Qty.
①	Bypass tube (Part no.: TL0806)	PFA	1 (Approx. 700 mm)
②	Outlet piping (With ball valve)	Stainless steel	1
③	Return port piping	Stainless steel	1
④	Nipple (Size: 1/2)	Stainless steel	2

Part no.	Applicable model
HRS-BP004	HRS040-□□-□
	HRS050-□□-□
	HRS060-□□-□

Parts List

No.	Description	Fluid contact material	Qty.
①	Hose	PVC	1 (Approx. 700 mm)
②	Outlet piping (With ball valve)	Stainless steel	1
③	Return port piping	Stainless steel	1
④	Nipple (Size: 1/2)	Stainless steel	2
⑤	Hose band	—	2

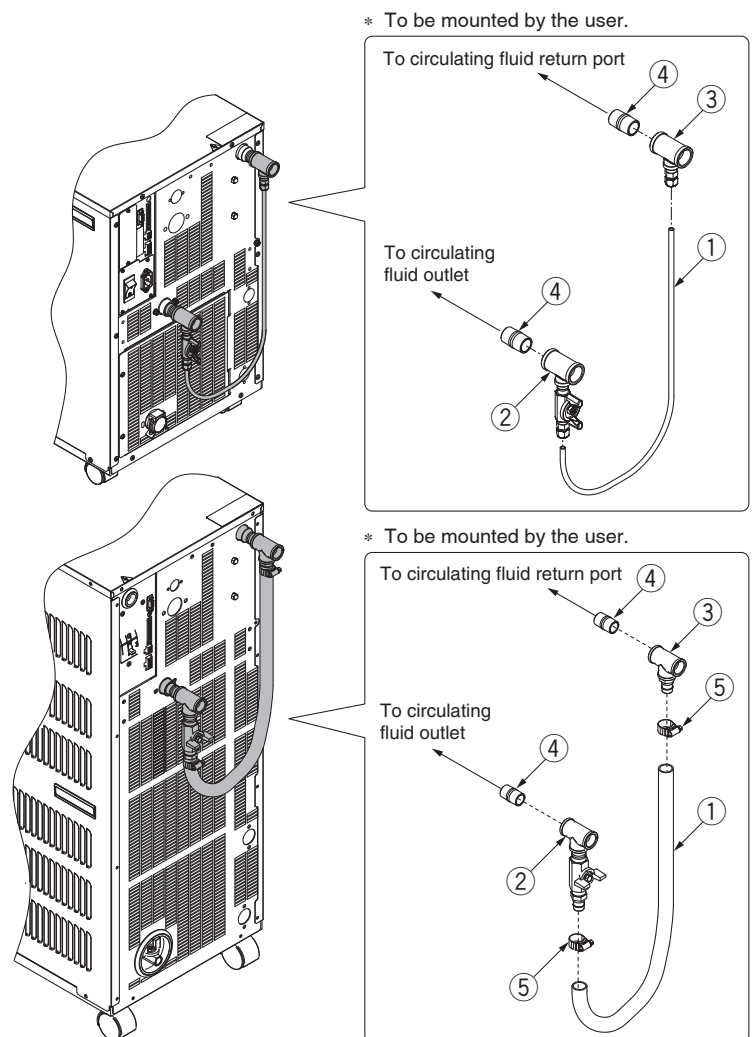

⑥ Power Supply Cable

■ For single-phase 100/115 VAC type

* Not applicable for the 200 V type.

Part no.	Applicable model
HRS-CA001	HRS012-□□-10
	HRS018-□□-10

* Not applicable to retaining clip.

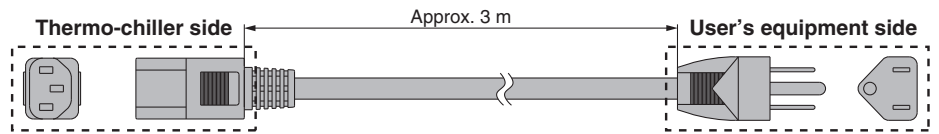

Part no.	Applicable model
HRS-CA003	HRS012-□□-10
	HRS018-□□-10

* Applicable to retaining clip.

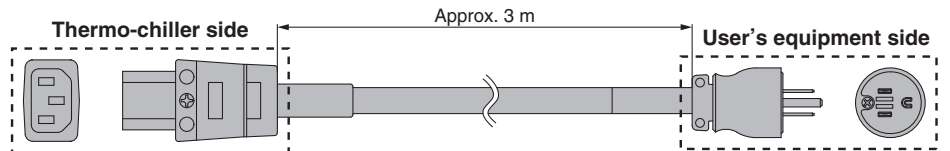

■ For single-phase 200 VAC type

* Not applicable for the 100 V type.

Part no.	Applicable model
HRS-CA002	HRS012-□□-20
	HRS018-□□-20
	HRS024-□□-20
	HRS030-□□-20

* Applicable to retaining clip.

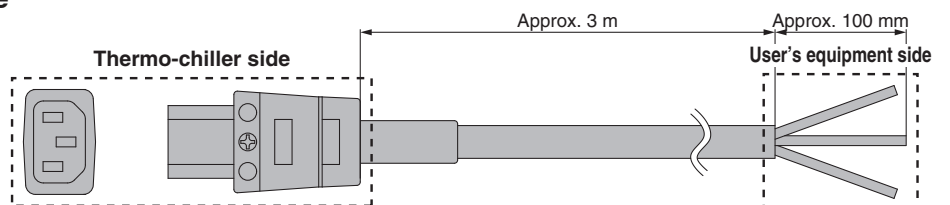

Part no.	Applicable model
HRS-CA004	HRS040-□□-20
	HRS050-□□-20
	HRS060-W□-20

* Not available for the HRS060-A□-20.
To be prepared by the user.

* Not applicable to retaining clip.

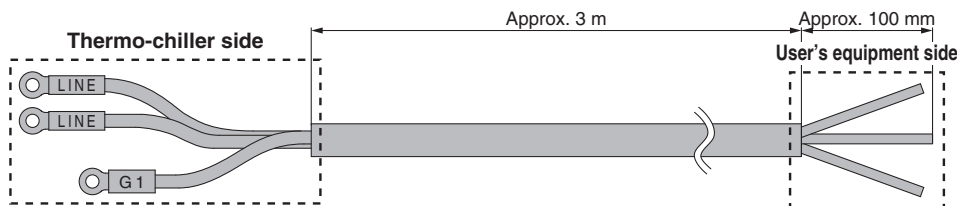

■ Retaining clip

Holds the connector on the thermo-chiller side in position.

Part no.	Applicable power supply cable
HRS-S0074	HRS-CA002
	HRS-CA003
	Power supply connector for accessory

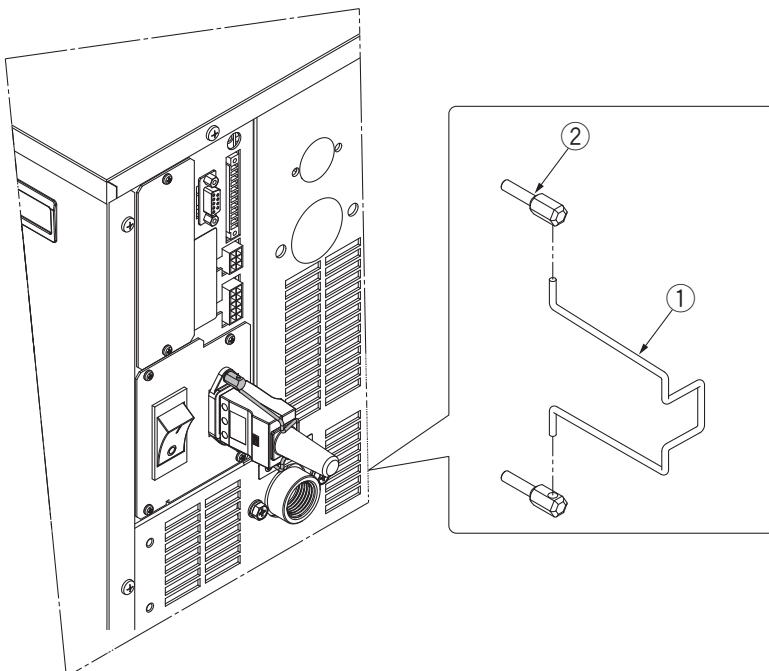

Parts List

No.	Description
①	Retaining clip
②	Holding screw

HRS Series

⑦ DI Filter Set

It is possible to retain the level of electric resistance and electric conductivity by flowing the circulating through the ion replacement resin (DI filter). The set parts are in order to install DI filter to bypass circuit and flow the fixed rate of the circulating fluid to DI filter. It is not to control the value of electric resistance and electric conductivity. (Replacement cartridge: HRS-DF001)

■ Stainless steel type

Suitable for locations with dusty atmospheres.

Part no.	Applicable model
HRS-DP001	HRS012-□□-□
	HRS018-□□-□
	HRS024-□□-□
	HRS030-□□-□
	HRS040-□□-□
	HRS050-□□-□
	HRS060-□□-□

* Cannot be installed in combination with particle filter set (HRS-PF001 to PF004).

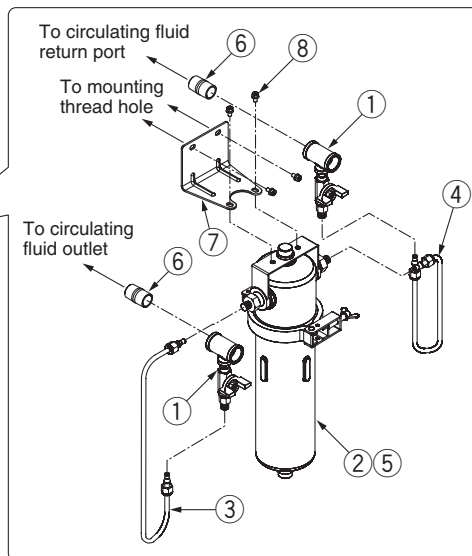
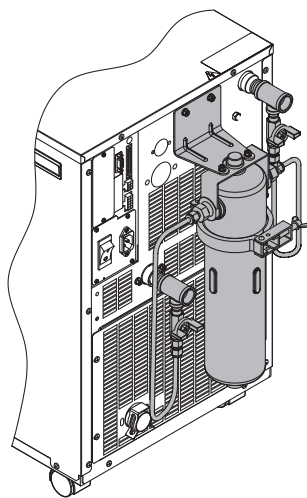

Parts List

No.	Description	Fluid contact material	Qty.
①	Branch line	Stainless steel	2
②	DI filter vessel	Stainless steel	1
③	DI filter inlet tube	PFA, POM	1
④	DI filter outlet tube	PFA, POM	1
⑤	DI filter cartridge (Part no.: HRS-DF001)*1	PP, PE	1
⑥	Nipple (Size: 1/2)	Stainless steel	2
⑦	Mounting bracket	—	1
⑧	Mounting screw (M6 screw, M5 screw)	—	2 pcs. each

*1 The product should be replaced when it can no longer preserve the electrical resistivity/electrical conductivity set values.

■ Resin type

Lightweight and compact

Can be installed in combination with the HRS-PF001, PF002.

Part no.	Applicable model
HRS-DP002	HRS012-□□-□
	HRS018-□□-□
	HRS024-□□-□
	HRS030-□□-□
	HRS040-□□-□
	HRS050-□□-□
	HRS060-□□-□

* Cannot be installed in combination with particle filter set (HRS-PF003, PF004).

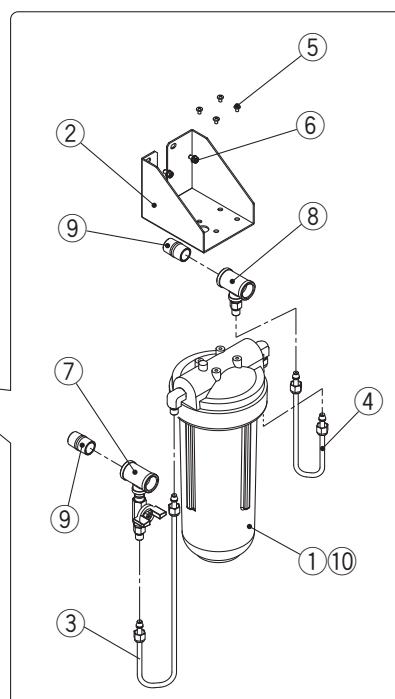
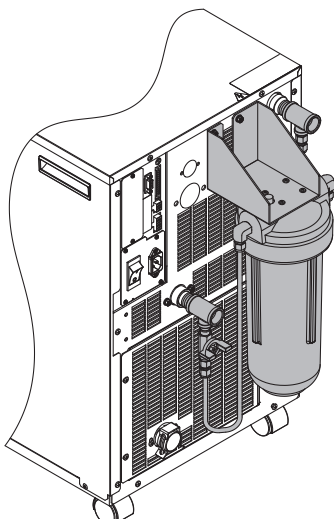

Parts List

No.	Description	Fluid contact material	Qty.
①	DI filter vessel	PC, PP	1
②	Mounting bracket	—	1
③	DI filter inlet tube	PFA, POM	1
④	DI filter outlet tube	PFA, POM	1
⑤	Tapping screw	—	4
⑥	Mounting screw (M5 screw)	—	2
⑦	Branch line for inlet	Stainless steel	1
⑧	Branch line for outlet	Stainless steel	1
⑨	Nipple (Size: 1/2)	Stainless steel	2
⑩	DI filter cartridge (Part no.: HRS-DF001)*1	PP, PE	1

*1 The product should be replaced when it can no longer preserve the electrical resistivity/electrical conductivity set values.

⑧ Electric Resistance Sensor Set/Electric Resistance Control Set

Option M needs to be selected at the time of purchase.
(When the electrical resistivity of the circulating fluid is 1 MΩ·cm or higher)

This product can be used to display, maintain, and control the electric resistivity of the circulating fluid (deionised water). The function differs according to the model (Refer to the table below). Refer to the Operation Manual for details.

Part no.	Applicable model
HRS-DI001 HRS-DI005	HRS012-□□-□
	HRS018-□□-□
	HRS024-□□-□
	HRS030-□□-□
	HRS040-□□-□
	HRS050-□□-□
HRS060-□□-□	
HRS-DI003 HRS-DI004	HRS012-□□-□
	HRS018-□□-□
	HRS024-□□-□
	HRS030-□□-□

List of Function

Optional accessories	Description	Electric resistivity display*1, *2	Electric resistivity maintenance	Electric resistivity control	Bypass*3
HRS-DI001	Electric resistance sensor set	○	X	X	X
HRS-DI003	Electric resistance control set	○	○	○	○
HRS-DI004	Electric resistance sensor set	○	○	X	○
HRS-DI005	Electric resistance control set	○	○	○	X

*1 Display range is 0 to 4.5 MΩ·cm.

*2 Readout using serial communications (RS-485/RS-232C) can be performed.

*3 This function is dedicated for the HRS-BP001 and cannot be used for the HRS040/050/060.

Specifications

	Electric resistance sensor set	Electric resistance control set
Measurement range of electric resistivity	0 to 4.5 MΩ·cm	
Set range of electric resistivity target	—	0.2 to 4.0 MΩ·cm
Set range of electric resistivity hysteresis	—	0.1 to 0.9 MΩ·cm
Operating temperature range (Circulating fluid temperature)	5 to 60 °C	
Operating pressure range	0.5 MPa or less	
Current consumption	100 mA or less	400 mA or less
Installation environment	Indoors	

[Mounting example: HRS012-A-20-M + HRS-DI001]

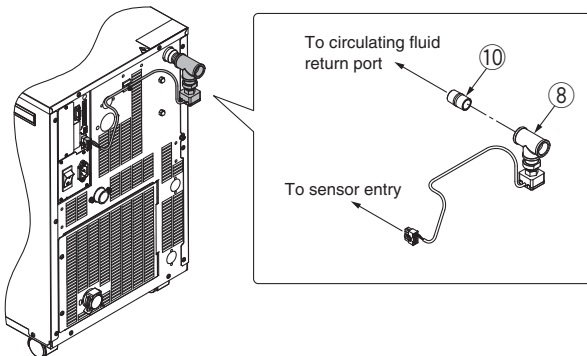

[Mounting example: HRS012-A-20-M + HRS-DI003]

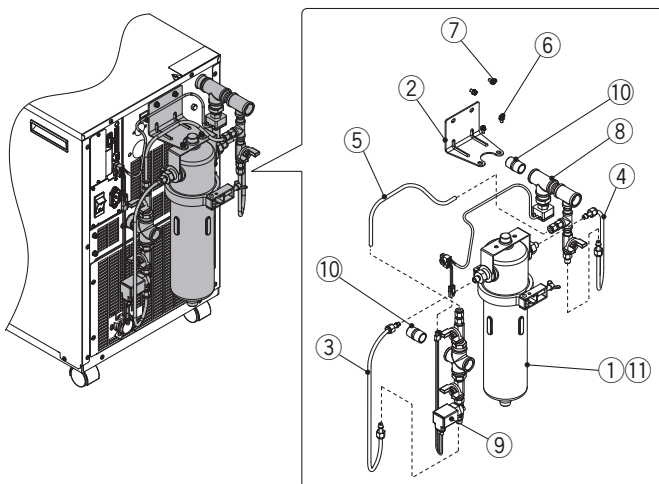

Parts List

No.	Description	Fluid contact material	Qty.			
			DI001	DI003	DI004	DI005
①	DI filter vessel	Stainless steel	—	1	1	—
		PC, PP	—	—	—	1
②	Mounting bracket	—	—	1	1	1
③	DI filter inlet tube	PFA, POM	—	1	1	1
④	DI filter outlet tube	PFA, POM	—	1	1	1
⑤	Bypass tube	PFA	—	1	1	—
⑥	Mounting screw (M6 screw)	—	—	2	2	—
⑦	Mounting screw (M5 screw)	—	—	2	2	6
⑧	Electric resistance sensor	Stainless steel, PPS	1	1	1	1
⑨	Solenoid valve for control	Stainless steel, EPDM	—	1	—	1
⑩	Nipple (Size: 1/2)	Stainless steel	1	2	2	2
⑪	DI filter cartridge (Part no.: HRS-DF001)*1	PP, PE	—	1	1	1

*1 The product should be replaced when it can no longer preserve the electrical resistivity set value.

⑨ Electric Conductivity Sensor Set/Electric Conductivity Control Set

This product can be used to display, maintain, and control the electric conductivity of the circulating fluid (deionised water). The function differs according to the model (Refer to the table below). Refer to the Operation Manual for details.

Part no.	Applicable model
HRS-DI008 HRS-DI011	HRS012-□□-□
	HRS018-□□-□
	HRS024-□□-□
	HRS030-□□-□
	HRS040-□□-□
	HRS050-□□-□ HRS060-□□-□
HRS-DI009	HRS012-□□-□
	HRS018-□□-□
	HRS024-□□-□
	HRS030-□□-□
	HRS030-□□-□

List of Function

Optional accessories	Description	Electric conductivity display*1,*2	Electric conductivity maintenance	Electric conductivity control	Bypass*3
HRS-DI008	Electric conductivity sensor set	○	X	X	X
HRS-DI009	Electric conductivity control set	○	○	○	○
HRS-DI011	Electric conductivity control set	○	○	○	X

*1 Display range is 2 to 48 $\mu\text{S}/\text{cm}$.

*2 Readout using serial communications (RS-485/RS-232C) can be performed.

*3 This function is dedicated for the HRS-BP001 and cannot be used for the HRS040/050/060.

Specifications

	Electric conductivity sensor set	Electric conductivity control set
Measurement range of electric conductivity	2.0 to 48.0 $\mu\text{S}/\text{cm}$	
Set range of electric conductivity target	—	5.0 to 45.0 $\mu\text{S}/\text{cm}$
Set range of electric conductivity hysteresis	—	2.0 to 10.0 $\mu\text{S}/\text{cm}$
Operating temperature range (Circulating fluid temperature)	5 to 60 °C	
Operating pressure range	0.5 MPa or less	
Current consumption	100 mA or less	400 mA or less
Installation environment	Indoors	

[Mounting example: HRS012-A-20 + HRS-DI008]

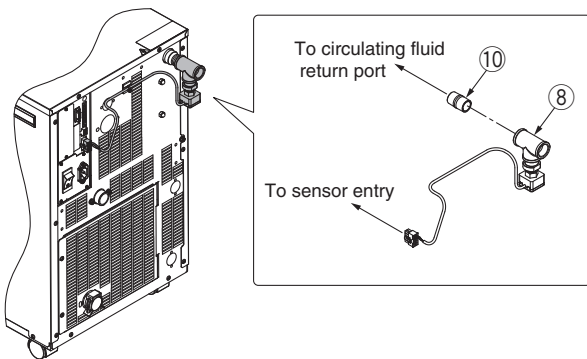

[Mounting example: HRS012-A-20 + HRS-DI009]

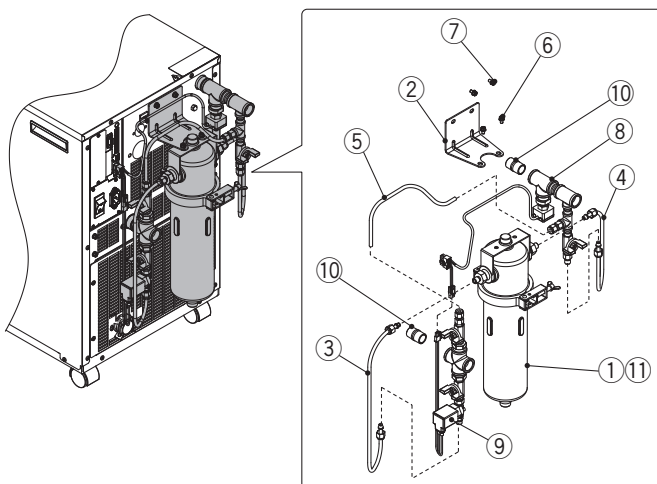

Parts List

No.	Description	Fluid contact material	Qty.		
			DI008	DI009	DI011
①	DI filter vessel	Stainless steel	—	1	—
		PC, PP	—	—	1
②	Mounting bracket	—	1	1	
③	DI filter inlet tube	PFA, POM	—	1	1
④	DI filter outlet tube	PFA, POM	—	1	1
⑤	Bypass tube	PFA	—	1	—
⑥	Mounting screw (M6 screw)	—	—	2	—
⑦	Mounting screw (M5 screw)	—	—	2	6
⑧	Electric conductivity sensor	Stainless steel, PPS	1	1	1
⑨	Solenoid valve for control	Stainless steel, EPDM	—	1	1
⑩	Nipple (Size: 1/2)	Stainless steel	1	2	2
⑪	DI filter cartridge (Part no.: HRS-DF001)*1	PP, PE	—	1	1

*1 The product should be replaced when it can no longer preserve the electrical conductivity set value.

⑩ Particle Filter Set

This set can be used to remove foreign matter from the circulating fluid.

HRS-PF001-W075-H

PF002
PF003
PF004

● **Filtration**

Symbol	Nominal filtration accuracy [μm]	Element part no. for PF001/ PF003 (individual part)	Element part no. for PF002/ PF004 (individual part)
—	Without element	—	—
W005	5	EJ202S-005X11	EJ302S-005X11
W075	75	EJ202S-075X11	EJ302S-075X11

● **Accessory**

Symbol	Accessory
—	None
H	With handle

■ **For circulating fluid outlet**
[Used to protect your tool]

Part no.	Applicable model
HRS-PF001 (Element length L = 125 mm)	HRS012-□□-□ HRS040-□□-□ HRS018-□□-□ HRS050-□□-□ HRS024-□□-□ HRS060-□□-□ HRS030-□□-□
HRS-PF002 (Element length L = 250 mm)	HRS050-□□-□ HRS060-□□-□

Mounting view

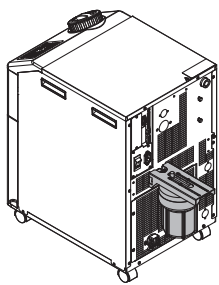

The following reference drawing shows the HRS-PF001 mounted on the HRS012 to 024. For details, refer to the dimensions or the Operation Manual.

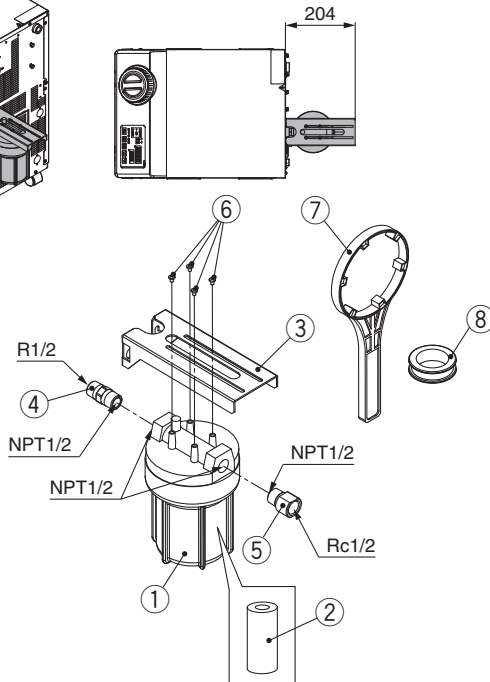

■ **For circulating fluid return port**
[Used to protect thermo-chiller]

If foreign matter such as scales in the piping enter the circulating fluid, this may cause the pump to malfunction. Therefore, it is strongly recommended to install the particle filter set.

Part no.	Applicable model
HRS-PF003 (Element length L = 125 mm)	HRS012-□□-□ HRS040-□□-□ HRS018-□□-□ HRS050-□□-□ HRS024-□□-□ HRS060-□□-□ HRS030-□□-□
HRS-PF004 (Element length L = 250 mm)	HRS050-□□-□ HRS060-□□-□

Mounting view

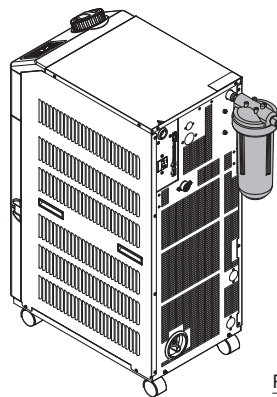

The following reference drawing shows the HRS-PF004 mounted on the HRS050/060. For details, refer to the dimensions or the Operation Manual.

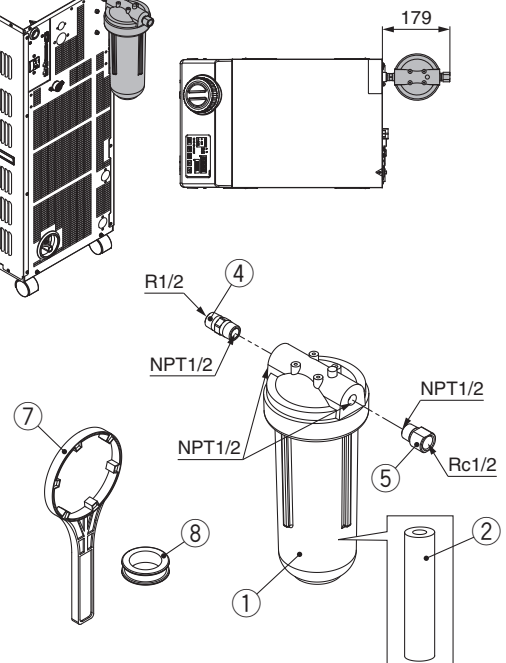

Parts List

No.	Model	Description	Fluid contact material	Qty.	Note
①	—	Body	PP	1	—
②	EJ202S-005X11	Element (Length L = 125 mm)	PP/PE	1	For HRS-PF001/003
	EJ202S-075X11			1	
	EJ302S-005X11	1		The product should be replaced when the pressure drop reaches 0.1 MPa.	
	EJ302S-075X11	1			
③	—	Particle filter bracket	—	1	For HRS-PF001/002
④	—	Nipple	Stainless steel	1	Conversion from R to NPT
⑤	—	Extension piece	Stainless steel	1	Conversion from NPT to Rc
⑥	—	Tapping screw	—	4	—
⑦	—	Handle	—	1	When -H is selected
⑧	—	Sealant tape	PTFE	1	—

HRS Series

⑪ Drain Pan Set (With Water Leakage Sensor)

Drain pan for the thermo-chiller. Liquid leakage from the thermo-chiller can be detected by mounting the attached water leakage sensor. Anchor bolt (M8) suitable for the flooring material should be prepared separately by the user.

Part no.	Applicable model
HRS-WL001	HRS012-□□-□
	HRS018-□□-□
	HRS024-□□-□
	HRS030-□□-□

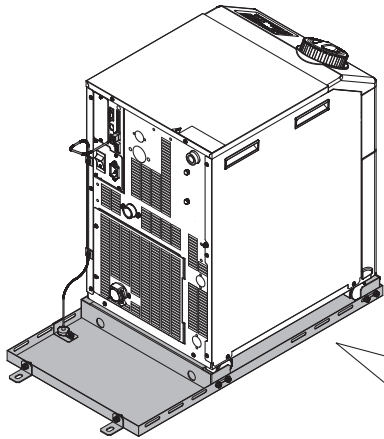

HRS012/018/024/030

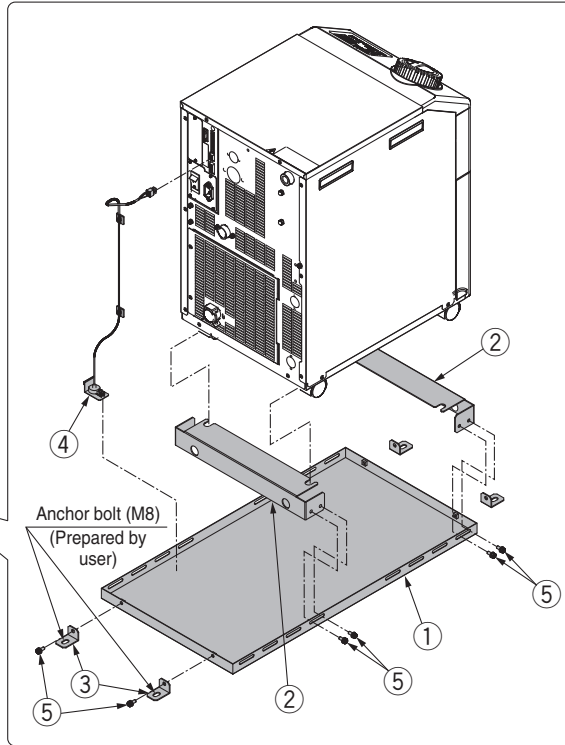

Parts List

No.	Description
①	Drain pan
②	Thermo-chiller fixing bracket (2 pcs.)
③	Drain pan fixing bracket (4 pcs.)
④	Water leakage sensor
⑤	Bracket fixing screw (M6 screw, 12 pcs.)

Part no.	Applicable model
HRS-WL002	HRS040-□□-□
	HRS050-□□-□
	HRS060-□□-□

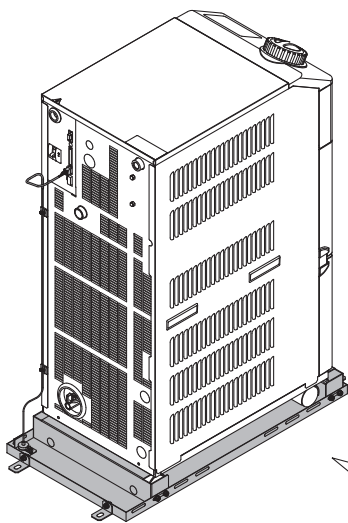

HRS050/060

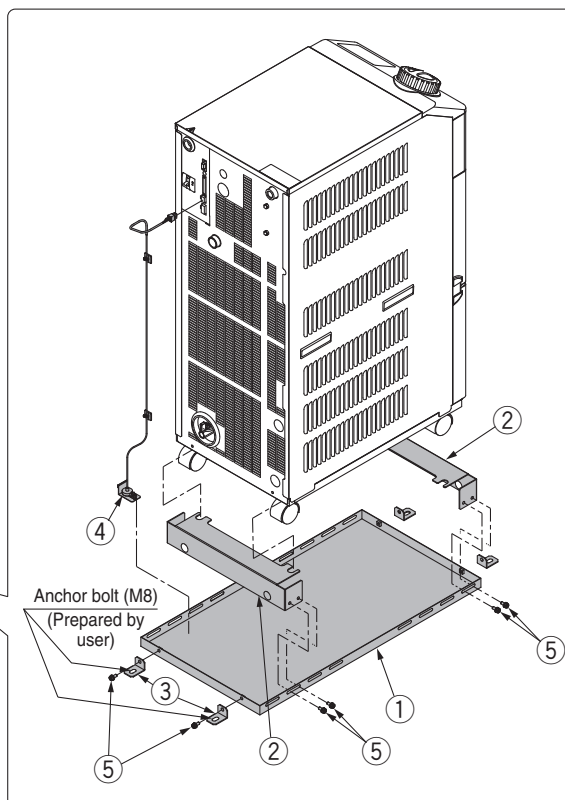

Parts List

No.	Description
①	Drain pan
②	Thermo-chiller fixing bracket (2 pcs.)
③	Drain pan fixing bracket (4 pcs.)
④	Water leakage sensor
⑤	Bracket fixing screw (M6 screw, 12 pcs.)

12 Connector Cover

This product can be used for protecting the connector on the rear side.

Part no.	Applicable model
HRS-BK001	HRS012-□□-□
	HRS018-□□-□
	HRS024-□□-□
	HRS030-□□-□

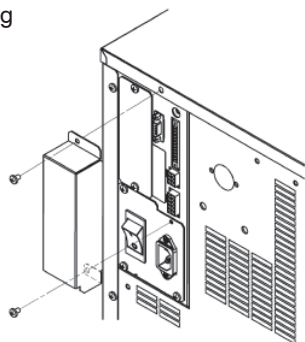

Part no.	Applicable model
HRS-BK002	HRS040-□□-□
	HRS050-□□-□
	HRS060-□□-□

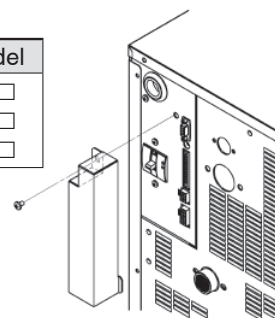

13 Analogue Gateway Unit

This is an expansion unit for adding analogue communication functions.
 “Analogue communication, contact input/output” functions can be used.

● Analogue communication

The set circulating fluid temperature can be changed by entering the analogue voltage.

Converts the current circulating fluid temperature and current electric resistance value (*1) to an analogue voltage for output.

*1 Displayed when optional “Electric resistance sensor set/HRS-DI001, DI003, DI004, and DI005” are used.

● Contact input/output

The Run/Stop of the thermo-chiller HRS series can be operated by a contact signal.

The contact signal of the operation status, alarm occurrence status and the TEMP READY status can also be output.

Part no.	Applicable model
HRS-CV001	HRS012-□□-□
	HRS018-□□-□
	HRS024-□□-□
	HRS030-□□-□
	HRS040-□□-□
	HRS050-□□-□
	HRS060-□□-□

Parts List

No.	Description
①	Analogue gateway box
②	Connection cable
③	Mounting bracket
④	Mounting screw (M3, 2 pcs.)

When this product is used, the “contact input/output” and “serial communication” functions standardly equipped in the thermo-chiller HRS series cannot be used.

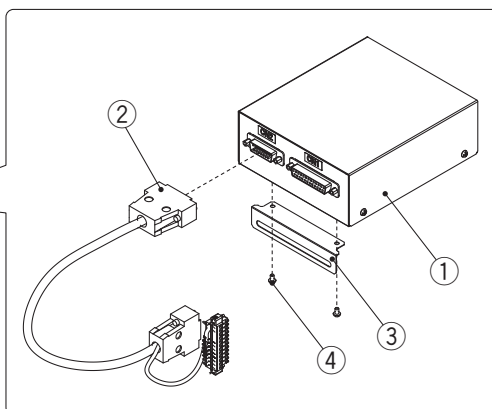
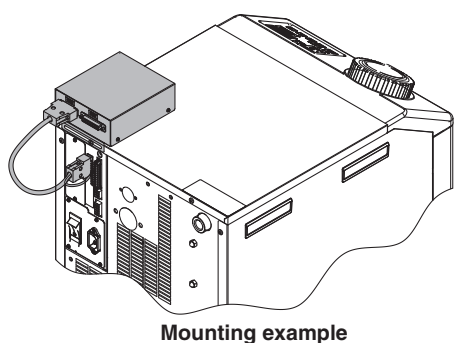

14 Replacement Type Dustproof Filter Set

A disposable dustproof filter is mounted instead of the dustproof net on the front panel.

Part no.	Applicable model
HRS-FL001	HRS012-A□-□
	HRS018-A□-□
	HRS024-A□-□

Parts List

No.	Description	Part no.	Note
①	Replacement type dustproof filter set	HRS-FL001	A front panel with hook-and-loop fastener for holding the filter, 5 filters are included. (No dustproof net is included.)
②	Replacement type dustproof filter	HRS-FL002	5 filters per set Size: 300 x 370

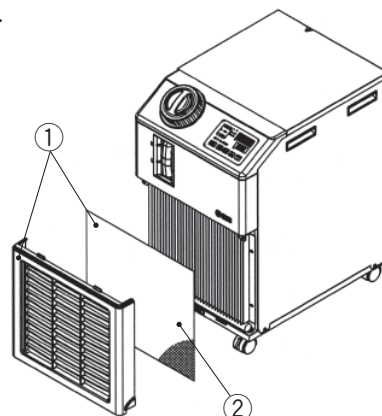

HRS Series

⑮ Separately-Installed Power Transformer

This transformer does not have CE/UKCA marking and is not compliant with UL standards.

Specifications

Part no.	Applicable model	Volume	Type	Inlet voltage		Outlet voltage	
				50 Hz	60 Hz	50 Hz	60 Hz
IDF-TR1000-1	HRS012-□-10 HRS018-□-10	1 kVA	Single-phase	110 VAC	120 VAC	100 VAC	100, 110 VAC
IDF-TR1000-2				240 VAC	240 to 260 VAC		
IDF-TR1000-3				380, 400, 415 VAC	380 to 420 VAC		
IDF-TR1000-4				420, 440, 480 VAC	420 to 520 VAC		
IDF-TR2000-9	HRS012-□-20 HRS018-□-20 HRS024-□-20 HRS030-□-20	2 kVA	Single-phase	—	240 VAC	200 VAC	200, 220 VAC
IDF-TR2000-10				380, 400, 415 VAC	380 to 400, 400 to 415, 415 to 440 VAC		
IDF-TR2000-11				440, 460 VAC	440 to 460, 460 to 500 VAC		

* For the HRS040/050/060 models: To be prepared by the user.

IDF-TR1000-1

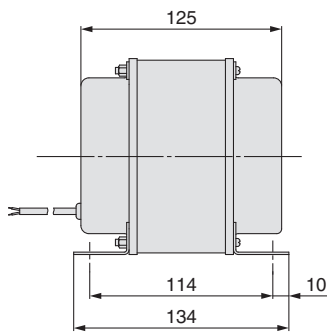

IDF-TR1000-2

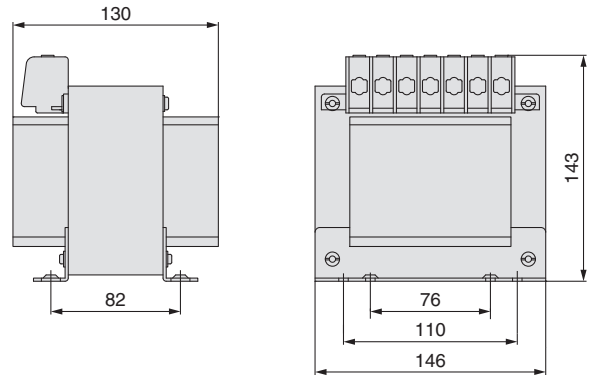

IDF-TR1000-3, 4

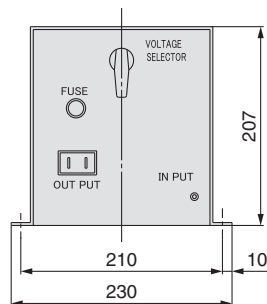
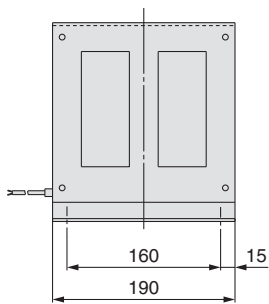

IDF-TR2000-9

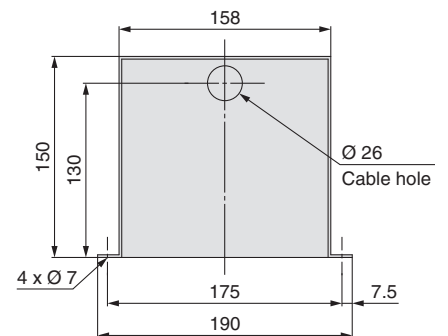
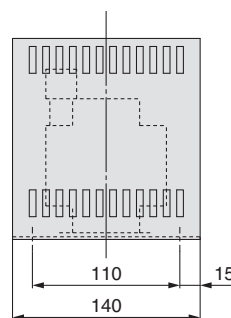

IDF-TR2000-10, 11

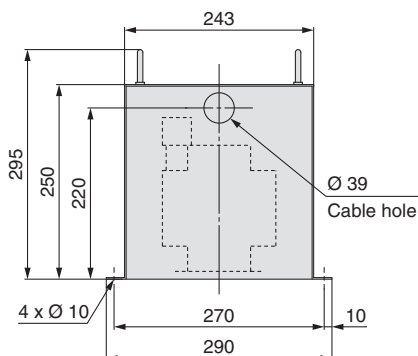
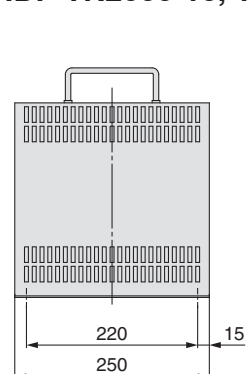

⑩ Filter for Circulating Fluid Fill Port

Prevents foreign matter from entering the tank when supplying the circulating fluid. Can be used just by fitting into the circulating fluid fill port.

■ Filter for circulating fluid fill port HRS-PF007

Material	Stainless steel 304, Stainless steel 316
Mesh size	200

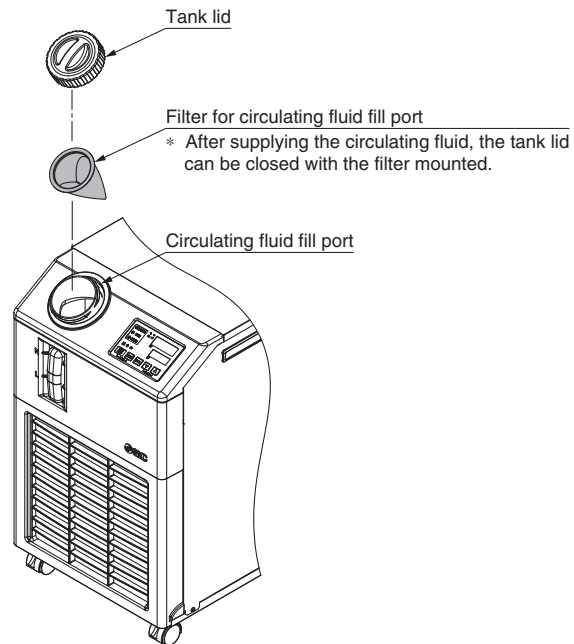

Cooling Capacity Calculation

Required Cooling Capacity Calculation

Example 1: When the heat generation amount in the user's equipment is known.

The heat generation amount can be determined based on the power consumption or output of the heat generating area — i.e. the area requiring cooling — within the user's equipment.*1

Q: Heat generation amount

① Derive the heat generation amount from the power consumption.

Power consumption P: 1000 [W]

$$Q = P = 1000 \text{ [W]}$$

Cooling capacity = Considering a safety factor of 20 %,

$$1000 \text{ [W]} \times 1.2 = 1200 \text{ [W]}$$

② Derive the heat generation amount from the power supply output.

Power supply output VI: 1.0 [kVA]

$$Q = P = V \times I \times \text{Power factor}$$

In this example, using a power factor of 0.85:

$$= 1.0 \text{ [kVA]} \times 0.85 = 0.85 \text{ [kW]} = 850 \text{ [W]}$$

Cooling capacity = Considering a safety factor of 20 %,

$$850 \text{ [W]} \times 1.2 = 1020 \text{ [W]}$$

③ Derive the heat generation amount from the output.

Output (shaft power, etc.) W: 800 [W]

$$Q = P = \frac{W}{\text{Efficiency}}$$

In this example, using an efficiency of 0.7:

$$= \frac{800}{0.7} = 1143 \text{ [W]}$$

Cooling capacity = Considering a safety factor of 20 %,

$$1143 \text{ [W]} \times 1.2 = 1372 \text{ [W]}$$

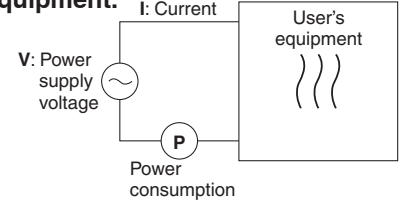

*1 The examples above calculate the heat generation amount based on the power consumption. The actual heat generation amount may differ due to the structure of the user's equipment. Be sure to check it carefully.

Example 2: When the heat generation amount in the user's equipment is not known.

Obtain the temperature difference between inlet and outlet by circulating the circulating fluid inside the user's equipment.

- Heat generation amount by user's equipment Q : Unknown [W] ([J/s])
- Circulating fluid : Tap water*1
- Circulating fluid mass flow rate q_m : ($= \rho \times q_v \div 60$) [kg/s]
- Circulating fluid density ρ : 1 [kg/dm³]
- Circulating fluid (volume) flow rate q_v : 10 [dm³/min]
- Circulating fluid specific heat C : 4.2×10^3 [J/(kg·K)]
- Circulating fluid outlet temperature T₁ : 293 [K] (20 [°C])
- Circulating fluid return temperature T₂ : 295 [K] (22 [°C])
- Circulating fluid temperature difference ΔT : 2.0 [K] (= T₂ - T₁)
- Conversion factor: minutes to seconds (SI units) : 60 [s/min]

*1 Refer to page 46 for the typical physical property value of tap water or other circulating fluids.

$$Q = q_m \times C \times (T_2 - T_1)$$

$$= \frac{\rho \times q_v \times C \times \Delta T}{60} = \frac{1 \times 10 \times 4.2 \times 10^3 \times 2.0}{60}$$

$$= 1400 \text{ [J/s]} \approx 1400 \text{ [W]}$$

Cooling capacity = Considering a safety factor of 20 %,

$$1400 \text{ [W]} \times 1.2 = 1680 \text{ [W]}$$

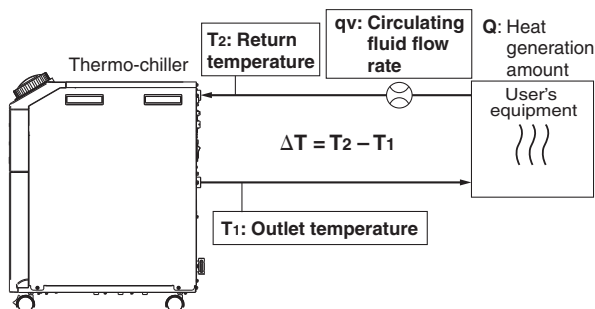

Example of conventional units (Reference)

- Heat generation amount by user's equipment Q : Unknown [cal/h] → [W]
- Circulating fluid : Tap water*1
- Circulating fluid weight flow rate q_m : ($= \rho \times q_v \times 60$) [kgf/h]
- Circulating fluid weight volume ratio γ : 1 [kgf/L]
- Circulating fluid (volume) flow rate q_v : 10 [l/min]
- Circulating fluid specific heat C : 1.0×10^3 [cal/(kgf·°C)]
- Circulating fluid outlet temperature T₁ : 20 [°C]
- Circulating fluid return temperature T₂ : 22 [°C]
- Circulating fluid temperature difference ΔT : 2.0 [°C] (= T₂ - T₁)
- Conversion factor: hours to minutes : 60 [min/h]
- Conversion factor: kcal/h to kW : 860 [(cal/h)/W]

$$Q = \frac{q_m \times C \times (T_2 - T_1)}{860}$$

$$= \frac{\gamma \times q_v \times 60 \times C \times \Delta T}{860}$$

$$= \frac{1 \times 10 \times 60 \times 1.0 \times 10^3 \times 2.0}{860}$$

$$= \frac{1200000 \text{ [cal/h]}}{860}$$

$$\approx 1400 \text{ [W]}$$

Cooling capacity = Considering a safety factor of 20 %,

$$1400 \text{ [W]} \times 1.2 = 1680 \text{ [W]}$$

Required Cooling Capacity Calculation

Example 3: When there is no heat generation, and when cooling the object below a certain temperature and period of time.

Heat quantity by cooled substance (per unit time) **Q**: Unknown [W] [(J/s)]
 Cooled substance : Water
 Cooled substance mass **m** : (= $\rho \times V$) [kg]
 Cooled substance density ρ : 1 [kg/L]
 Cooled substance total volume **V** : 20 [dm³]
 Cooled substance specific heat **C** : 4.2×10^3 [J/(kg·K)]
 Cooled substance temperature when cooling begins **T₀**: 305 [K] (32 [°C])
 Cooled substance temperature after t hour **T_t** : 293 [K] (20 [°C])
 Cooling temperature difference ΔT : 12 [K] (= $T_0 - T_t$)
 Cooling time Δt : 900 [s] (= 15 [min])

* Refer to the following for the typical physical property values by circulating fluid.

$$Q = \frac{m \times C \times (T_0 - T_t)}{\Delta t} = \frac{\rho \times V \times C \times \Delta T}{\Delta t}$$

$$= \frac{1 \times 20 \times 4.2 \times 10^3 \times 12}{900} = 1120 \text{ [J/s]} \approx 1120 \text{ [W]}$$

Cooling capacity = Considering a safety factor of 20 %,

$$1120 \text{ [W]} \times 1.2 = \mathbf{1344 \text{ [W]}}$$

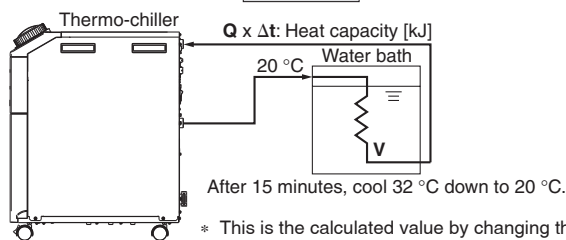

Example of conventional units (Reference)

Heat quantity by cooled substance (per unit time) **Q**: Unknown [cal/h] → [W]
 Cooled substance : Water
 Cooled substance weight **m** : (= $\rho \times V$) [kgf]
 Cooled substance weight volume ratio γ : 1 [kgf/L]
 Cooled substance total volume **V** : 20 [L]
 Cooled substance specific heat **C** : 1.0×10^3 [cal/(kgf·°C)]
 Cooled substance temperature when cooling begins **T₀** : 32 [°C]
 Cooled substance temperature after t hour **T_t**: 20 [°C]
 Cooling temperature difference ΔT : 12 [°C] (= $T_0 - T_t$)
 Cooling time Δt : 15 [min]
 Conversion factor: hours to minutes : 60 [min/h]
 Conversion factor: kcal/h to kW : 860 [(cal/h)/W]

$$Q = \frac{m \times C \times (T_0 - T_t)}{\Delta t \times 860} = \frac{\gamma \times V \times 60 \times C \times \Delta T}{\Delta t \times 860}$$

$$= \frac{1 \times 20 \times 60 \times 1.0 \times 10^3 \times 12}{15 \times 860}$$

$$\approx 1120 \text{ [W]}$$

Cooling capacity = Considering a safety factor of 20 %,

$$1120 \text{ [W]} \times 1.2 = \mathbf{1344 \text{ [W]}}$$

Precautions on Cooling Capacity Calculation

1. Heating capacity

When the circulating fluid temperature is set above room temperature, it needs to be heated by the thermo-chiller. The heating capacity depends on the circulating fluid temperature. Consider the radiation rate and heat capacity of the user's equipment and check beforehand if the required heating capacity is provided.

2. Pump capacity

<Circulating fluid flow rate>

Circulating fluid flow rate varies depending on the circulating fluid discharge pressure. Consider the installation height difference between the thermo-chiller and the user's equipment, and the piping resistance such as circulating fluid pipings, or piping size, or piping curves in the machine. Check beforehand if the required flow is achieved, using the pump capacity curves.

<Circulating fluid discharge pressure>

Circulating fluid discharge pressure has the possibility to increase up to the maximum pressure in the pump capacity curves. Check beforehand if the circulating fluid pipings or circulating fluid circuit of the user's equipment are fully durable against this pressure.

Circulating Fluid Typical Physical Property Values

1. This catalogue uses the following values for density and specific heat in calculating the required cooling capacity.

Density ρ : 1 [kg/L] (or, using conventional units, weight volume ratio $\gamma = 1$ [kgf/L])
 Specific heat **C**: 4.19×10^3 [J/(kg·K)] (or, using conventional units, 1×10^3 [cal/(kgf·°C)])

2. Values for density and specific heat change slightly according to temperature shown below. Use this as a reference.

Water

Physical property value Temperature	Density ρ [kg/L]	Specific heat C [J/(kg·K)]	Conventional units	
			Weight volume ratio γ [kgf/L]	Specific heat C [cal/(kgf·°C)]
5 °C	1.00	4.2×10^3	1.00	1×10^3
10 °C	1.00	4.19×10^3	1.00	1×10^3
15 °C	1.00	4.19×10^3	1.00	1×10^3
20 °C	1.00	4.18×10^3	1.00	1×10^3
25 °C	1.00	4.18×10^3	1.00	1×10^3
30 °C	1.00	4.18×10^3	1.00	1×10^3
35 °C	0.99	4.18×10^3	0.99	1×10^3
40 °C	0.99	4.18×10^3	0.99	1×10^3

15 % Ethylene Glycol Aqueous Solution

Physical property value Temperature	Density ρ [kg/L]	Specific heat C [J/(kg·K)]	Conventional units	
			Weight volume ratio γ [kgf/L]	Specific heat C [cal/(kgf·°C)]
5 °C	1.02	3.91×10^3	1.02	0.93×10^3
10 °C	1.02	3.91×10^3	1.02	0.93×10^3
15 °C	1.02	3.91×10^3	1.02	0.93×10^3
20 °C	1.01	3.91×10^3	1.01	0.93×10^3
25 °C	1.01	3.91×10^3	1.01	0.93×10^3
30 °C	1.01	3.91×10^3	1.01	0.94×10^3
35 °C	1.01	3.91×10^3	1.01	0.94×10^3
40 °C	1.01	3.92×10^3	1.01	0.94×10^3

* Shown above are reference values. Contact circulating fluid supplier for details.



HRS Series

Specific Product Precautions 1

Be sure to read this before handling the products. Refer to the back cover for safety instructions. For temperature control equipment precautions, refer to the “Handling Precautions for SMC Products” and the “Operation Manual” on the SMC website: <https://www.smc.eu>

Design

Warning

1. This catalogue shows the specifications of a single unit.

- 1) Check the specifications of the single unit (contents of this catalogue) and thoroughly consider the adaptability between the user's system and this unit.
- 2) Although the protection circuit as a single unit is installed, prepare a drain pan, water leakage sensor, discharge air facility, and emergency stop equipment, depending on the user's operating condition. Also, the user is requested to carry out the safety design for the whole system.

2. When attempting to cool areas that are open to the atmosphere (tanks, pipes), plan your piping system accordingly.

When cooling open-air external tanks, arrange the piping so that there are coil pipes for cooling inside the tanks, and to carry back the entire flow volume of circulating fluid that is released.

3. Use non-corrosive material for fluid contact parts of circulating fluid.

The recommended circulating fluid is the tap water or 15 % ethylene glycol aqueous solution. Using corrosive materials such as aluminium or iron for fluid contact parts such as piping may cause clogging or leakage in the circulating fluid circuit. Therefore, take sufficient care when selecting fluid contact part materials such as piping.

4. Design the piping so that no foreign matter enter the chiller.

If foreign matter such as scales in the piping enter the circulating fluid, this may cause the pump to malfunction. In particular, when the option T (High-pressure pump mounted) or HRS050/060 is used, it is strongly recommended to install the particle filter.

Selection

Warning

1. Model selection

For selecting a model of thermo-chiller, it is required to know the heat generation amount of the user's equipment. Obtain the heat generation amount, referring to “Cooling Capacity Calculation” on pages 45 and 46 before selecting a model.

Handling

Warning

1. Thoroughly read the Operation Manual.

Read the Operation Manual completely before operation, and keep the manual where it can be referred to as necessary.

Transportation/Carriage/Movement

Warning

1. This product is heavy. Pay attention to safety and position of the product when it is transported, carried and moved.

2. Read the Operation Manual carefully to move the product after unpacking.

Caution

1. Never put the product down sideways as this may cause failure.

The product will be delivered in the packaging shown below.

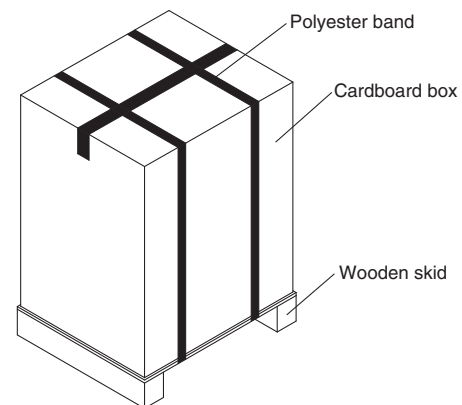

Model	Weight [kg]*1	Dimensions [mm]
HRS012-□□-10 HRS018-□□-10	49	Height 790 x Width 470 x Depth 580
HRS012-□□-20 HRS018-□□-20 HRS024-□□-20	52	Height 790 x Width 470 x Depth 580
HRS030-A□-20	56	Height 830 x Width 470 x Depth 580
HRS030-W□-20	55	
HRS040-□□-20	63	Height 900 x Width 450 x Depth 670
HRS050-A□-20	80	Height 1160 x Width 450 x Depth 670
HRS050-W□-20	78	
HRS060-A□-20	84	
HRS060-W□-20	78	

*1 For models with an option, the weights are increased as below.

Option symbol	Description	Additional weight
-B	With earth leakage breaker	No addition
-J	With automatic fluid fill function	+1 kg
-M	Applicable to deionised water piping	No addition
-T	High-pressure pump mounted (100 V type)	+4 kg
	High-pressure pump mounted (200 V type)	+6 kg
-G	High-temperature environment specification	No addition



HRS Series

Specific Product Precautions 2

Be sure to read this before handling the products. Refer to the back cover for safety instructions. For temperature control equipment precautions, refer to the “Handling Precautions for SMC Products” and the “Operation Manual” on the SMC website: <https://www.smc.eu>

Operating Environment/Storage Environment

Warning

1. Do not use in the following environment as it will lead to a breakdown.

- 1) Outdoors
- 2) In locations where water, water vapour, salt water, and oil may splash on the product
- 3) In locations where there are dust and particles
- 4) In locations where corrosive gases, organic solvents, chemical fluids, or flammable gases are present (This product is not explosion proof.)
- 5) In locations where the ambient temperature exceeds the limits as mentioned below
 - During transportation/storage: 0 to 50 °C (But as long as water or circulating fluid are not left inside the pipings)
 - During operation: 5 to 40 °C (When option G, high-temperature environment specification, is selected: 5 to 45 °C)
- 6) In locations where the ambient humidity is out of the following range or where condensation occurs
 - During transportation/storage: 15 to 85 %
 - During operation: 30 to 70 %
- 7) In locations which receive direct sunlight or radiated heat
- 8) In locations where there is a heat source nearby and the ventilation is poor
- 9) In locations where temperature substantially changes
- 10) In locations where strong magnetic noise occurs (In locations where strong electric fields, strong magnetic fields, and surge voltage occur)
- 11) In locations where static electricity occurs, or conditions which make the product discharge static electricity
- 12) In locations where high frequency occurs
- 13) In locations where damage is likely to occur due to lightning
- 14) In locations at altitude of 3000 m or higher (Except during storage and transportation)

* For altitude of 1000 m or higher

Because of lower air density, the heat radiation efficiencies of the devices in the product will be lower in the location at altitude of 1000 m or higher. Therefore, the maximum ambient temperature to use and the cooling capacity will lower according to the descriptions in the table below.

Select the thermo-chiller considering the descriptions.

- ① Upper limit of ambient temperature: Use the product in ambient temperature of the described value or lower at each altitude.
- ② Cooling capacity coefficient: The product’s cooling capacity will lower to one that multiplied by the described value at each altitude.

Altitude [m]	① Upper limit of ambient temperature [°C]		② Cooling capacity coefficient
	40 °C products	45 °C products (For high-temperature environment specification, Option G)	
Less than 1000 m	40	45	1.00
Less than 1500 m	38	42	0.85
Less than 2000 m	36	38	0.80
Less than 2500 m	34	35	0.75
Less than 3000 m	32	32	0.70

- 15) In locations where strong impacts or vibrations occur
- 16) In locations where a massive force strong enough to deform the product is applied or the weight from a heavy object is applied
- 17) In locations where there is not sufficient space for maintenance

2. Install in an environment where the unit will not come into direct contact with rain or snow.

These models are for indoor use only. Do not install outdoors where rain or snow may fall on them.

3. Conduct ventilation and cooling to discharge heat. (Air-cooled refrigeration)

The heat which is cooled down through air-cooled condenser is discharged. When using in a room which is shut tightly, ambient temperature will exceed the specification range stipulated in this catalogue, which will activate the safety detector and stop the operation. In order to avoid this situation, discharge the heat outside of a room by ventilation or cooling facilities.

4. The product is not designed for clean room usage. It generates particles internally.



HRS Series Specific Product Precautions 3

Be sure to read this before handling the products. Refer to the back cover for safety instructions. For temperature control equipment precautions, refer to the "Handling Precautions for SMC Products" and the "Operation Manual" on the SMC website: <https://www.smc.eu>

Mounting/Installation

Warning

1. Do not use the product outdoors.
2. Do not place heavy objects on top of this product, or step on it.
The external panel can be deformed and danger can result.

Caution

1. Install on a rigid floor which can withstand this product's weight.
2. When installing without the casters, use the adjuster feet, etc. to raise the chiller to the following heights or more.
This product cannot be directly installed on the floor as some screws come out from the bottom of the product.
 - HRS012 to 030 10 mm
 - HRS040 to 060 15 mm
3. Refer to the Operation Manual for this product, and secure an installation space that is necessary for the maintenance and ventilation.

<Air-cooled refrigeration>

1. The air-cooled type product exhausts heat using the fan that is mounted to the product. If the product is operated with insufficient ventilation, ambient temperature may exceed 40 °C* 1, and this will affect the performance and life of the product. To prevent this ensure that suitable ventilation is available (see below).
 - *1 When option G, high-temperature environment specification, is selected: 45 °C
2. For installation indoors, ventilation ports and a ventilation fan should be equipped as needed.

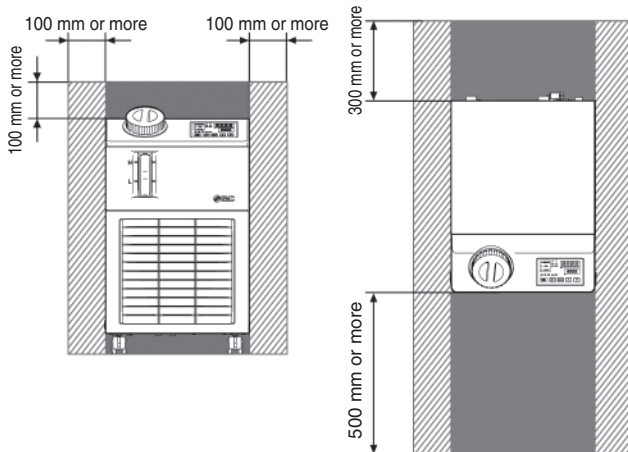

When option G, high-temperature environment specification, is selected: HRS030/HRS040/HRS050/HRS060 (A ventilation space is required since the ventilation slots are provided on the sides of the product.)

<Heat radiation amount/Required ventilation rate>

Model	Heat radiation amount [kW]	Required ventilation rate [m ³ /min]	
		Differential temp. of 3 °C between inside and outside of installation area	Differential temp. of 6 °C between inside and outside of installation area
HRS012-A	Approx. 2	40	20
HRS018-A	Approx. 4	70	40
HRS024-A	Approx. 5	90	50
HRS030-A	Approx. 6	100	60
HRS040-A	Approx. 8	120	70
HRS050-A	Approx. 10	140	70
HRS060-A	Approx. 10	140	70

Piping

Caution

1. Regarding the circulating fluid pipings, consider carefully the suitability for shutoff pressure, temperature and circulating fluid.
If the operating performance is not sufficient, the pipings may burst during operation. Also, the use of corrosive materials such as aluminium or iron for fluid contact parts, such as piping, may not only lead to clogging or leakage in the circulating fluid and facility water circuits but also refrigerant leakage and other unexpected problems. Provide protection against corrosion when you use the product.
2. Select the piping port size which can exceed the rated flow.
For the rated flow, refer to the pump capacity table.
3. When tightening at the circulating fluid inlet and outlet, drain port or overflow port of this product, use a pipe wrench to clamp the connection ports.
4. For the circulating fluid piping connection, install a drain pan and wastewater collection pit just in case the circulating fluid may leak.
5. This product series is constant-temperature fluid circulating machines with built-in tanks.
Do not install equipment on your system side such as pumps that forcibly return the circulating fluid to the unit. Also, if you attach an external tank that is open to the air, it may become impossible to circulate the circulating fluid. Proceed with caution.

Electrical Wiring

Warning

1. Grounding should never be connected to a water line, gas line or lightning rod.

Caution

1. Communication cable should be prepared by the user.
2. Provide a stable power supply which is not affected by surge or distortion.

If the voltage increase ratio (dV/dt) at the zero cross should exceed 40 V/200 μsec., it may result in malfunction.

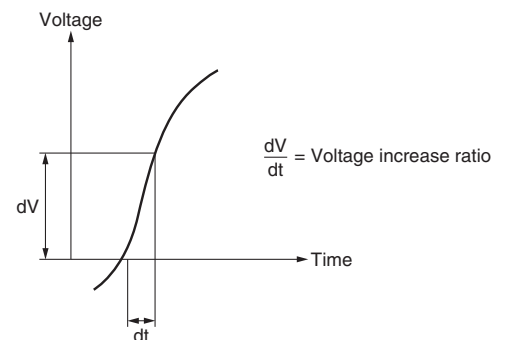



HRS Series

Specific Product Precautions 4

Be sure to read this before handling the products. Refer to the back cover for safety instructions. For temperature control equipment precautions, refer to the “Handling Precautions for SMC Products” and the “Operation Manual” on the SMC website: <https://www.smc.eu>

Circulating Fluid

⚠ Caution

1. Avoid oil or other foreign matter entering the circulating fluid.
2. When water is used as a circulating fluid, use tap water that conforms to the appropriate water quality standards.
Use tap water that conforms to the standards shown below (including water used for dilution of ethylene glycol aqueous solution).

Tap Water (as a Circulating Fluid) Quality Standards

The Japan Refrigeration and Air Conditioning Industry Association
JRA GL-02-1994 “Cooling water system – Circulation type – Make-up water”

	Item	Unit	Standard value	Influence	
				Corrosion	Scale generation
Standard item	pH (at 25 °C)	—	6.0 to 8.0	○	○
	Electric conductivity (25 °C)	[μS/cm]	100*1 to 300*1	○	○
	Chloride ion (Cl ⁻)	[mg/L]	50 or less	○	
	Sulfuric acid ion (SO ₄ ²⁻)	[mg/L]	50 or less	○	
	Acid consumption amount (at pH4.8)	[mg/L]	50 or less		○
	Total hardness	[mg/L]	70 or less		○
	Calcium hardness (CaCO ₃)	[mg/L]	50 or less		○
Reference item	Ionic state silica (SiO ₂)	[mg/L]	30 or less		○
	Iron (Fe)	[mg/L]	0.3 or less	○	○
	Copper (Cu)	[mg/L]	0.1 or less	○	
	Sulfide ion (S ₂ ⁻)	[mg/L]	Should not be detected.	○	
	Ammonium ion (NH ₄ ⁺)	[mg/L]	0.1 or less	○	
	Residual chlorine (Cl)	[mg/L]	0.3 or less	○	
	Free carbon (CO ₂)	[mg/L]	4.0 or less	○	

*1 In the case of [MΩ·cm], it will be 0.003 to 0.01.

- : Factors that have an effect on corrosion or scale generation
- Even if the water quality standards are met, complete prevention of corrosion is not guaranteed.

3. Use an ethylene glycol aqueous solution that does not contain additives such as preservatives.
4. When using ethylene glycol aqueous solution, maintain a maximum concentration of 15%.
Overly high concentrations can cause a pump overload. Low concentrations, however, can lead to freezing when circulating fluid temperature is 10 °C or lower and cause the thermo-chiller to break down.
5. A magnet pump or mechanical seal pump is used as the circulating pump for the circulating fluid.
It is particularly impossible to use liquid including metallic powders such as iron powder.
6. The circulating fluids listed below have been tested for thermo-chiller compatibility.

No.	Fluid	Manufacturer	Concentration
1	Dowcal™ 100 Heat Transfer Fluid	The Dow Chemical Company	Dilute to 30 % in water
2	ControXid 1642	Oelheld GmbH	Ready to use
3	Hexid A4	Applied Thermal Control Limited	Ready to use
4	Coolflow IGE	Hydratech Division of Liquitherm Technologies Group Ltd	Dilute to 25 % in water
5	NALCO® CCL105	Nalco Water, an Ecolab Company	Ready to use

- The chiller cooling capacity and pump capacity performance may change with using the fluids listed. Customers should verify the performances with the fluid and decide to use the fluid.
- Check the compatibility with the piping and the wetted parts of the customer's equipment before use.
- Check with the circulating fluid manufacturer for the following.
 - 1) Countries and regions where it can be obtained and used
 - 2) Handling and maintenance
 - 3) Safety data sheets
 - 4) Specifications and physical properties
- Concentration has to be value listed or less. Overly high concentrations can cause a pump overload. Low concentrations, however, can lead to freezing when circulating fluid temperature is 10 °C or lower and cause the thermo-chiller to break down.
- Using the fluid listed for a long time, the chiller heat exchanger performance may be reduced due to additive deposits. It is recommended to regularly flush the inside of the piping and chiller with clean water.
- In the case of a mechanical seal pump, additive deposits may appear on the outside, it is not a malfunction.

Facility Water Supply

⚠ Warning

<Water-cooled refrigeration>

1. The water-cooled refrigeration type thermo-chiller radiates heat to the facility water.
Prepare the facility water system that satisfies the heat radiation and the facility water specifications below.

■ Required facility water system

<Heat radiation amount/Facility water specifications>

Model	Heat radiation [kW]	Facility water specifications
HRS012-W□-□	Approx. 2	Refer to “Facility water system” in the specifications.
HRS018-W□-□	Approx. 4	
HRS024-W□-20	Approx. 5	
HRS030-W□-20	Approx. 6	
HRS040-W□-20	Approx. 8	
HRS050-W□-20	Approx. 10	
HRS060-W□-20	Approx. 12	

2. When using tap water as facility water, use tap water that conforms to the appropriate water quality standards.
Use tap water that conforms to the standards shown below. If the water quality standards are not met, clogging or leakage in the facility water piping, or other problems such as refrigerant leakage, etc., may result.

<Tap Water (as a Facility Water) Quality Standards>

The Japan Refrigeration and Air Conditioning Industry Association
JRA GL-02-1994 “Cooling water system – Circulation type – Circulating water”

	Item	Unit	Standard value	Influence	
				Corrosion	Scale generation
Standard item	pH (at 25 °C)	—	6.5 to 8.2	○	○
	Electric conductivity (25 °C)	[μS/cm]	100*1 to 800*1	○	○
	Chloride ion (Cl ⁻)	[mg/L]	200 or less	○	
	Sulfuric acid ion (SO ₄ ²⁻)	[mg/L]	200 or less	○	
	Acid consumption amount (at pH4.8)	[mg/L]	100 or less		○
	Total hardness	[mg/L]	200 or less		○
	Calcium hardness (CaCO ₃)	[mg/L]	150 or less		○
Reference item	Ionic state silica (SiO ₂)	[mg/L]	50 or less		○
	Iron (Fe)	[mg/L]	1.0 or less	○	○
	Copper (Cu)	[mg/L]	0.3 or less	○	
	Sulfide ion (S ₂ ⁻)	[mg/L]	Should not be detected.	○	
	Ammonium ion (NH ₄ ⁺)	[mg/L]	1.0 or less	○	
	Residual chlorine (Cl)	[mg/L]	0.3 or less	○	
	Free carbon (CO ₂)	[mg/L]	4.0 or less	○	

*1 In the case of [MΩ·cm], it will be 0.001 to 0.01.

- : Factors that have an effect on corrosion or scale generation
- Even if the water quality standards are met, complete prevention of corrosion is not guaranteed.
- We recommend to use the filter kit, FQ1011N-04-T020-B-X61, when you do not know the quality of circulating fluid to prevent leakage and other issues.

3. Supply pressure of 0.5 MPa or less.

If the supply pressure is high, it will cause water leakage.

4. Be sure to prepare your utilities so that the pressure of the thermo-chiller facility water outlet is at 0 MPa (atmospheric pressure) or more.

If the facility water outlet pressure becomes negative, the internal facility water piping may collapse, and proper flow control of facility water will be impossible.

Using deionised water as facility water may cause problems such as clogging in the piping due to metal ion.

5. Do not use fluid that includes metallic powders and other foreign materials.

It can cause issues: clogging of the circulating fluid circuit or leakage.



HRS Series

Specific Product Precautions 5

Be sure to read this before handling the products. Refer to the back cover for safety instructions. For temperature control equipment precautions, refer to the “Handling Precautions for SMC Products” and the “Operation Manual” on the SMC website: <https://www.smc.eu>

Operation

⚠ Warning

1. Confirmation before operation

1) The fluid level of a tank should be within the specified range of “HIGH” and “LOW.”

When exceeding the specified level, the circulating fluid will overflow.

2) Remove the air.

Conduct a trial operation, looking at the fluid level.

Since the fluid level will go down when the air is removed from the user’s piping system, supply water once again when the fluid level is reduced. When there is no reduction in the fluid level, the job of removing the air is completed.

Pump can be operated independently.

2. Confirmation during operation

● Check the circulating fluid temperature.

The operating temperature range of the circulating fluid is between 5 and 40 °C.

When the amount of heat generated from the user’s equipment is greater than the product’s capability, the circulating fluid temperature may exceed this range. Use caution regarding this matter.

3. Emergency stop method

● When an abnormality is confirmed, stop the machine immediately. After pushing the [OFF] switch, be sure to turn off the power switch.

Operation Restart Time/Operation and Suspension Frequency

⚠ Caution

1. Wait five minutes or more before restarting operation after it has been stopped. If the operation is restarted within five minutes, the protection circuit may activate and the operation may not start properly.

2. Operation and suspension frequency should not exceed 10 times per day. Frequently switching between operation and suspension may result in the malfunction of the refrigeration circuit.

Protection Circuit

⚠ Caution

1. If operating in the below conditions, the protection circuit will activate and an operation may not be performed or will stop.

- Power supply voltage is not within the rated voltage range of ±10 %.
- In case the water level inside the tank is reduced abnormally.
- Circulating fluid temperature is too high.
- Compared to the cooling capacity, the heat generation amount of the user’s equipment is too high.
- Ambient temperature is too high. (40 °C or more)
- Refrigerant pressure is too high.
- Ventilation hole is clogged with dust or dirt.

■ Trademark Information

Modbus® is a registered trademark of Schneider Electric, licensed to the Modbus Organization, Inc.

Maintenance

⚠ Caution

<Periodical inspection every one month>

1. Clean the ventilation hole.

If the dustproof filter becomes clogged with dust or debris, a decline in cooling performance can result.

In order to avoid deforming or damaging the dustproof filter, clean it with a long-haired brush or air gun.

<Periodical inspection every three months>

1. Inspect the circulating fluid.

1) When using tap water

● Replacement of tap water

Failure to replace the tap water can lead to the development of bacteria and algae. Replace it regularly according to your usage conditions.

● Tank cleaning

Consider whether dirt, slime, or foreign matter may be present in the circulating fluid inside the tank, and carry out regular cleanings of the tank.

2) When using ethylene glycol aqueous solution

Use a concentration meter to confirm that the concentration does not exceed 15 %.

Dilute or add as needed to adjust the concentration.

<Periodical inspection during the winter season>

1. Make water-removal arrangements beforehand.

If there is a risk of the circulating fluid freezing when the product is stopped, release the circulating fluid in advance.

2. Contact a professional.

For additional methods to prevent freezing (such as commercially available tape heaters, etc.), contact a professional for advice.

■ Refrigerant with GWP reference



Refrigerant	Global warming potential (GWP)	
	Regulation (EU) No 517/2014 (Based on the IPCC AR4)	Revised Fluorocarbons Recovery and Destruction Law (Japanese law)
R134a	1,430	1,430
R404A	3,922	3,920
R407C	1,774	1,770
R410A	2,088	2,090

* This product is hermetically sealed and contains fluorinated greenhouse gases (HFC). When this product is sold on the market in the EU after January 1, 2017, it needs to be compliant with the quota system of the F-Gas Regulation in the EU.

* See specification table for refrigerant used in the product.

Safety Instructions

These safety instructions are intended to prevent hazardous situations and/or equipment damage. These instructions indicate the level of potential hazard with the labels of “Caution,” “Warning” or “Danger.” They are all important notes for safety and must be followed in addition to International Standards (ISO/IEC)¹⁾, and other safety regulations.

-  **Caution:** **Caution** indicates a hazard with a low level of risk which, if not avoided, could result in minor or moderate injury.
-  **Warning:** **Warning** indicates a hazard with a medium level of risk which, if not avoided, could result in death or serious injury.
-  **Danger:** **Danger** indicates a hazard with a high level of risk which, if not avoided, will result in death or serious injury.

- 1) ISO 4414: Pneumatic fluid power – General rules relating to systems.
ISO 4413: Hydraulic fluid power – General rules relating to systems.
IEC 60204-1: Safety of machinery – Electrical equipment of machines.
(Part 1: General requirements)
ISO 10218-1: Manipulating industrial robots - Safety.
etc.

Warning

1. The compatibility of the product is the responsibility of the person who designs the equipment or decides its specifications.

Since the product specified here is used under various operating conditions, its compatibility with specific equipment must be decided by the person who designs the equipment or decides its specifications based on necessary analysis and test results. The expected performance and safety assurance of the equipment will be the responsibility of the person who has determined its compatibility with the product. This person should also continuously review all specifications of the product referring to its latest catalogue information, with a view to giving due consideration to any possibility of equipment failure when configuring the equipment.

2. Only personnel with appropriate training should operate machinery and equipment.

The product specified here may become unsafe if handled incorrectly. The assembly, operation and maintenance of machines or equipment including our products must be performed by an operator who is appropriately trained and experienced.

3. Do not service or attempt to remove product and machinery/equipment until safety is confirmed.

1. The inspection and maintenance of machinery/equipment should only be performed after measures to prevent falling or runaway of the driven objects have been confirmed.
2. When the product is to be removed, confirm that the safety measures as mentioned above are implemented and the power from any appropriate source is cut, and read and understand the specific product precautions of all relevant products carefully.
3. Before machinery/equipment is restarted, take measures to prevent unexpected operation and malfunction.

4. Contact SMC beforehand and take special consideration of safety measures if the product is to be used in any of the following conditions.

1. Conditions and environments outside of the given specifications, or use outdoors or in a place exposed to direct sunlight.
2. Installation on equipment in conjunction with atomic energy, railways, air navigation, space, shipping, vehicles, military, medical treatment, combustion and recreation, or equipment in contact with food and beverages, emergency stop circuits, clutch and brake circuits in press applications, safety equipment or other applications unsuitable for the standard specifications described in the product catalogue.
3. An application which could have negative effects on people, property, or animals requiring special safety analysis.
4. Use in an interlock circuit, which requires the provision of double interlock for possible failure by using a mechanical protective function, and periodical checks to confirm proper operation.

Caution

1. The product is provided for use in manufacturing industries.

The product herein described is basically provided for peaceful use in manufacturing industries.

If considering using the product in other industries, consult SMC beforehand and exchange specifications or a contract if necessary. If anything is unclear, contact your nearest sales branch.

Limited warranty and Disclaimer/Compliance Requirements

The product used is subject to the following “Limited warranty and Disclaimer” and “Compliance Requirements”. Read and accept them before using the product.

Limited warranty and Disclaimer

1. The warranty period of the product is 1 year in service or 1.5 years after the product is delivered, whichever is first.²⁾ Also, the product may have specified durability, running distance or replacement parts. Please consult your nearest sales branch.
 2. For any failure or damage reported within the warranty period which is clearly our responsibility, a replacement product or necessary parts will be provided. This limited warranty applies only to our product independently, and not to any other damage incurred due to the failure of the product.
 3. Prior to using SMC products, please read and understand the warranty terms and disclaimers noted in the specified catalogue for the particular products.
- 2) Vacuum pads are excluded from this 1 year warranty.
A vacuum pad is a consumable part, so it is warranted for a year after it is delivered. Also, even within the warranty period, the wear of a product due to the use of the vacuum pad or failure due to the deterioration of rubber material are not covered by the limited warranty.

Compliance Requirements

1. The use of SMC products with production equipment for the manufacture of weapons of mass destruction (WMD) or any other weapon is strictly prohibited.
2. The exports of SMC products or technology from one country to another are governed by the relevant security laws and regulations of the countries involved in the transaction. Prior to the shipment of a SMC product to another country, assure that all local rules governing that export are known and followed.

Caution

SMC products are not intended for use as instruments for legal metrology.

Measurement instruments that SMC manufactures or sells have not been qualified by type approval tests relevant to the metrology (measurement) laws of each country. Therefore, SMC products cannot be used for business or certification ordained by the metrology (measurement) laws of each country.

Safety Instructions

Be sure to read “Handling Precautions for SMC Products” (M-E03-3) before using.

SMC Corporation (Europe)

Austria	+43 (0)2262622800	www.smc.at	office@smc.at
Belgium	+32 (0)33551464	www.smc.be	info@smc.be
Bulgaria	+359 (0)2807670	www.smc.bg	office@smc.bg
Croatia	+385 (0)13707288	www.smc.hr	office@smc.hr
Czech Republic	+420 541424611	www.smc.cz	office@smc.cz
Denmark	+45 70252900	www.smc.dk.com	smc@smcdk.com
Estonia	+372 651 0370	www.smcee.ee	info@smcee.ee
Finland	+358 207513513	www.smc.fi	smc.fi@smc.fi
France	+33 (0)164761000	www.smc-france.fr	supportclient@smc-france.fr
Germany	+49 (0)61034020	www.smc.de	info@smc.de
Greece	+30 210 2717265	www.smchellas.gr	sales@smchellas.gr
Hungary	+36 23513000	www.smc.hu	office@smc.hu
Ireland	+353 (0)14039000	www.smcautomation.ie	sales@smcautomation.ie
Italy	+39 03990691	www.smcitalia.it	mailbox@smcitalia.it
Latvia	+371 67817700	www.smc.lv	info@smc.lv

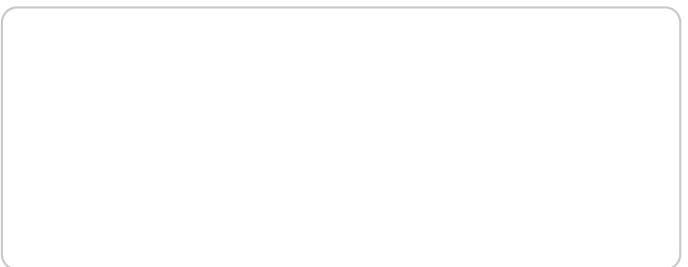

Lithuania	+370 5 2308118	www.smclt.lt	info@smclt.lt
Netherlands	+31 (0)205318888	www.smc.nl	info@smc.nl
Norway	+47 67129020	www.smc-norge.no	post@smc-norge.no
Poland	+48 222119600	www.smc.pl	office@smc.pl
Portugal	+351 214724500	www.smc.eu	apoioclientept@smc.smces.es
Romania	+40 213205111	www.smcromania.ro	smcromania@smcromania.ro
Russia	+7 (812)3036600	www.smc.eu	sales@smcru.com
Slovakia	+421 (0)413213212	www.smc.sk	office@smc.sk
Slovenia	+386 (0)73885412	www.smc.si	office@smc.si
Spain	+34 945184100	www.smc.eu	post@smc.smces.es
Sweden	+46 (0)86031240	www.smc.nu	smc@smc.nu
Switzerland	+41 (0)523963131	www.smc.ch	info@smc.ch
Turkey	+90 212 489 0 440	www.smcturkey.com.tr	info@smcturkey.com.tr
UK	+44 (0)845 121 5122	www.smc.uk	sales@smc.uk
South Africa	+27 10 900 1233	www.smcza.co.za	zasales@smcza.co.za